

ANUBIS MUSIC MISSION



MISSION APPENDIX

06.10.2021

Contents

MUSIC MISSION APPENDIX	5
DRIVERS INSTALLATION	5
Switching ON MERGING+ANUBIS.....	6
ANUBIS HOME PAGE and MUSIC MISSION LAUNCH	7
I/O Connectivity to your System/DAW.....	8
TOUCHSCREEN AND NAVIGATION.....	11
ANUBIS+MUSIC MISSION	12
Missions I/O Channels Specifications	14
OPERATION MODES.....	15
MUSIC MISSION SCHEMATIC.....	16
MULTIPLE POSSIBILITIES.....	17
ANUBIS+MUSIC A MIXER TOPOLOGY.....	18
THE MIXER.....	19
MIXER LAYOUT	20
Strip Channel Layout Diagram	21
Mixer Channel Detailed	22
Channel Fader.....	23
Channel indications & options.....	26
CUES MONITORING CONTROLS.....	30
MIXER CONTROL COLUMN	33
REFERENCE LEVEL	34
MIXERS (Control Column).....	35
BUS PARAMETERS.....	46
BUS ROUTING (Mixers Menu)	46
MENU OPTIONS (Control Column).....	51
STRIPS SETUP	52
SNAPSHOTS	53
PEERING	55
How to peer a device.....	57

Peering Rules.....	61
Multiple Anubis Peering.....	62
ANUBIS BUILT-IN EFFECTS.....	65
MERGING+EQ.....	66
MERGING+DYNAMICS.....	70
MERGING+REVERB.....	74
PREAMPS CONTROL.....	79
INPUTS OPTIONS:.....	80
PEERED PREAMPS.....	84
SETTINGS CATEGORIES DESCRIPTION.....	88
MUSIC SECTION.....	101
MIXING Settings.....	102
MONITORING Settings.....	104
INFO Settings.....	110
DEBUG Settings.....	110
EXIT Settings.....	111
ANUBIS ROOM CORRECTION WITH SONARWORKS SOUNDID REFERENCE.....	112
BASIC MUSIC SETUP.....	119
RECORDING SETUP WITH CUES.....	122
HARDWARE INSERTS.....	124
MONITORING WEB USER INTERFACE.....	126
How to Open the Remote Web User Interface.....	127
Tablets Remote Access - Using the Anubis IP Address.....	136
TROUBLESHOOTING.....	137
FOR MORE INFORMATION.....	138

Thank you for choosing MERGING+ANUBIS

MUSIC MISSION APPENDIX

This appendix comes as a supplement to the Anubis User Manual and is intended to take you through the ANUBIS+MUSIC mission in details. We encourage you to first familiarize yourself with MERGING+ANUBIS User Manual prior to reading this appendix.

To ensure the safe operation of your Anubis please read the instructions, important safety information and warnings carefully before installation and use.

DRIVERS INSTALLATION

For Drivers installation refer to the Generic Anubis User Manual or to the Merging online database <https://confluence.merging.com/pages/viewpage.action?pageId=45449231>

The Anubis Music Mission supports the following operating systems.

Windows 7 – 64 bit

Merging RAVENNA ASIO Driver

Windows 10 – 64 bit

Merging Audio Device (MAD)

Merging RAVENNA ASIO Driver

MacOS support: High Sierra – Mojave – Catalina – Big Sur (Intel & M1)

RAVENNA Virtual Audio Device Premium 3.0 and above

Linux OS – ALSA

RAVENNA/AES67

ANEMAN version 1.3 and above should be installed in order to manage your RAVENNA/AES67 AoIP connections.

Important. Make sure your Anubis has the most recent firmware installed. Verify the Firmware version by going to the Settings>Info Page.

Anubis Downloads and Procedures:

<https://www.merging.com/anubis/download>

Switching ON MERGING+ANUBIS

1. Press the switch on the unit's rear panel next to the DC input, as shown on the Back-Panel figure.

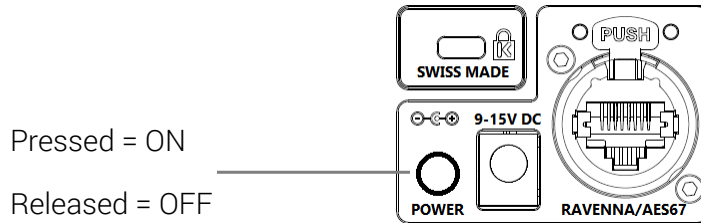

2. The Anubis Soft buttons will light up orange when the unit initiates the boot-up sequence, the TFT display will follow soon after. During this time the unit will perform a series of self-test and initialization routines.
3. Once the Anubis TFT display shows the Home page, the unit is ready for use.
Note: To turn OFF Anubis, press the POWER button to the released state.

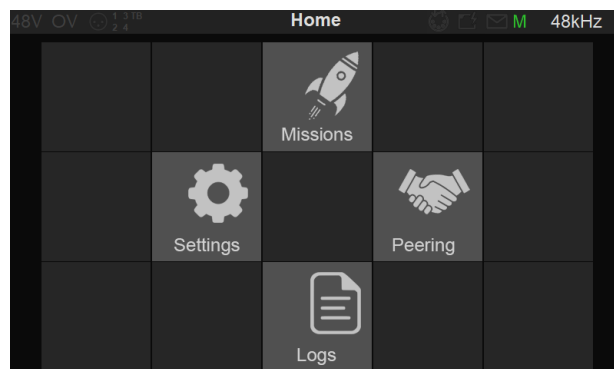

ANUBIS HOME PAGE and MUSIC MISSION LAUNCH

The Anubis Home page provides access to the Settings and Preamps pages and the Logs (messages).

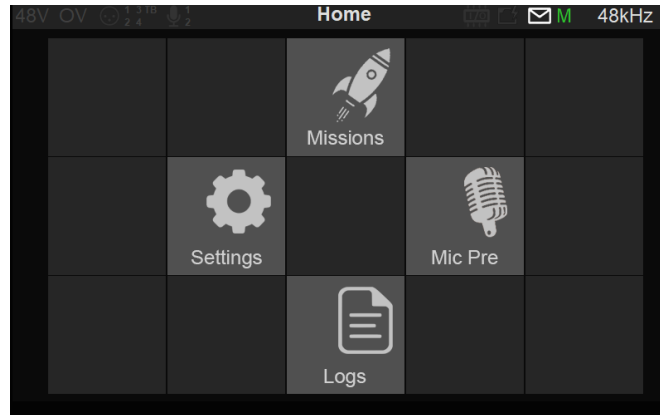

The Anubis Home page can at all times be accessed by long pressing the Anubis Home button



Enter the Missions page pressing the Missions icon



Load the Mission you plan to use. The Music Mission and the Monitoring Mission are available. This Guide focuses on the Music Mission.

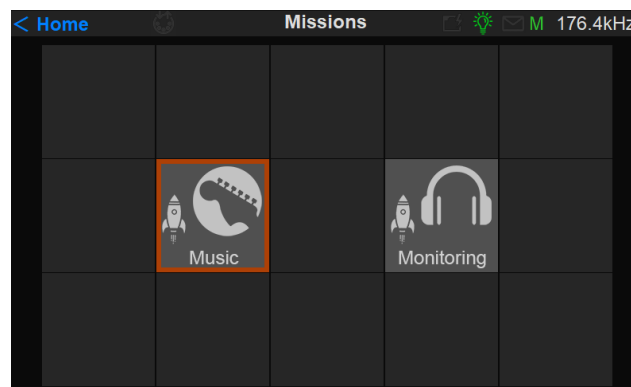

If you do not see the Music Mission icon, make sure you are on the latest Anubis Firmware (1.2.1b and above required).

Once the Music Mission is selected and launched the Main Mixer Music Mission Page will be displayed and ready for operations.

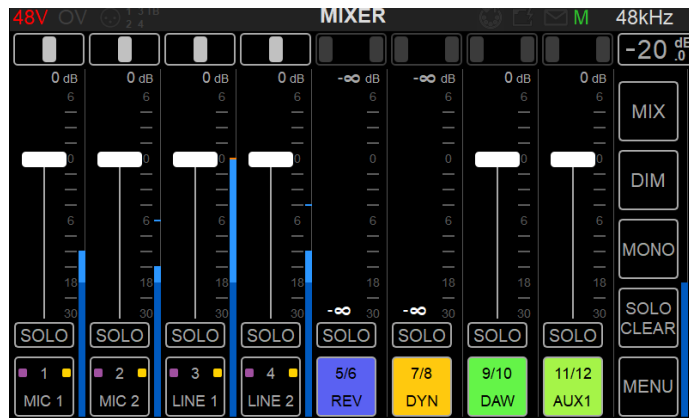

I/O Connectivity to your System/DAW

Anubis being a network audio interface, users wishing to use Anubis along with a system application such as a DAW will first need to establish the I/O network stream connections between Anubis their system's Merging Driver.

1. The first requirement is having our drivers installed: **MAD** (Windows 10) or **VAD** (MacOS). <https://confluence.merging.com/pages/viewpage.action?pageId=45449231>
Note: Users running Pyramix MassCore do not require a driver.

2. Once the driver is installed and running, users should open the MAD or VAD Panel. It is recommended to use the **UNITE** feature within the Driver panel that provides a simple and automatic way to make your AoIP I/O streams connections.

3. Make sure you first select the **UNITE** Tab.

MAD- PC (Win10)

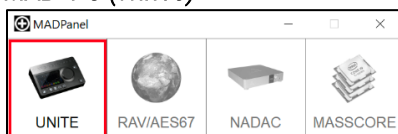

VAD - MacOS

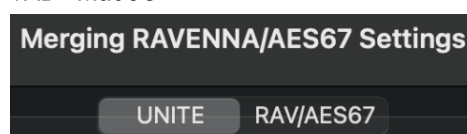

*Note: Users requiring more flexibility and for more complex AoIP setups with multiple devices should use the RAV/AES67 mode that requires the use of ANEMAN.
The Anubis Monitor Mission does not support UNITE, The Music Mission, Horus and Hapi do.*

4. Click the Anubis available to UNITE

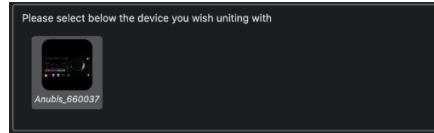
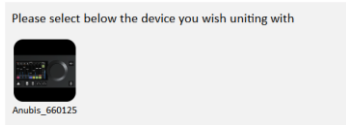

5. Select the Anubis I/O's you wish to UNITE, those I/O's will then be available for use along your system application or DAW and press the UNITE button.

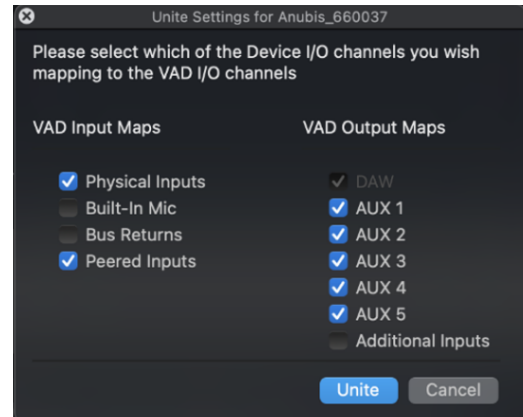
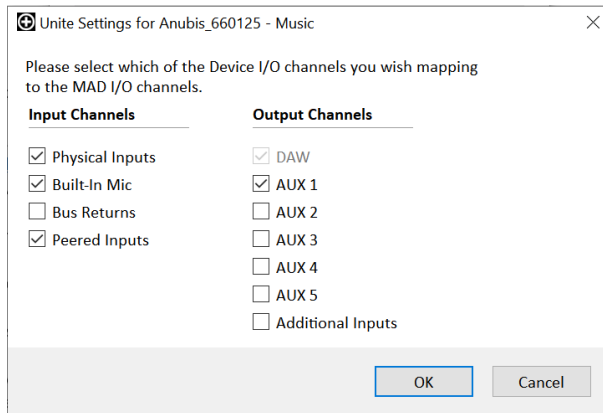

You should then see successful Unite indications, and be able to use Anubis along with your system application/DAW.

MAD- Successful UNITE

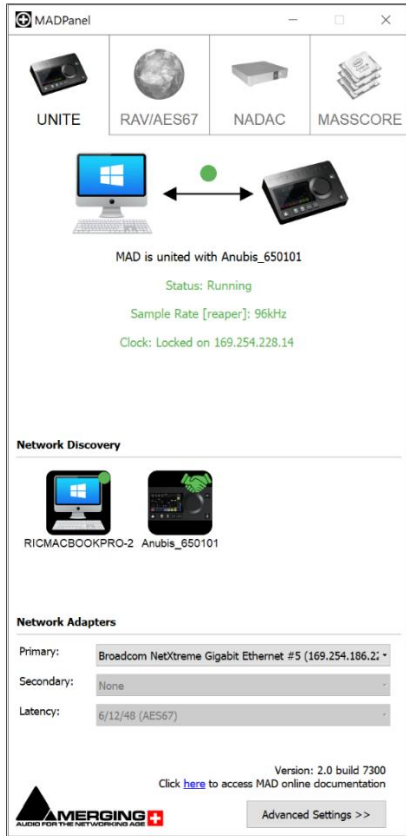

VAD - Successful UNITE

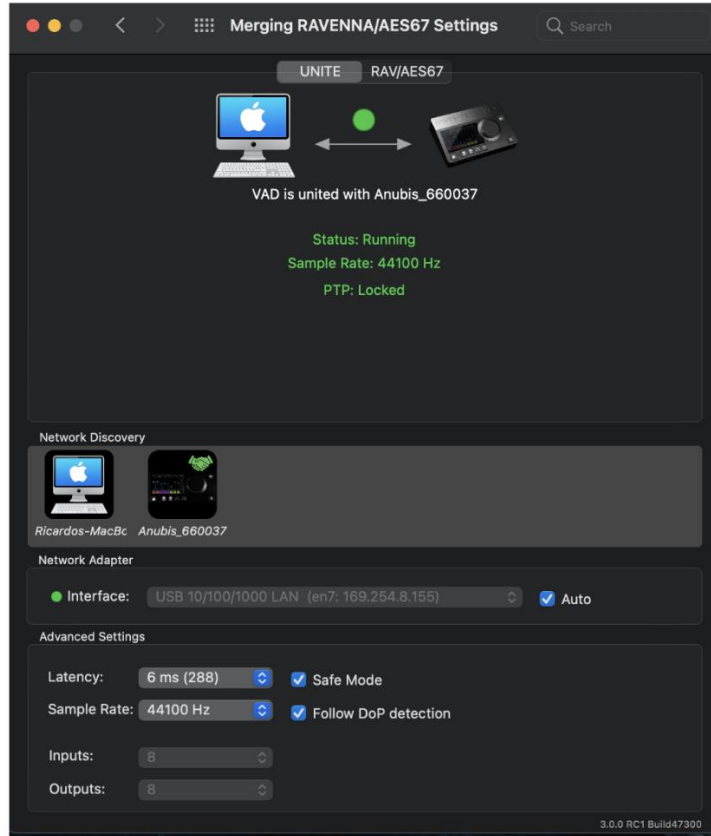

More details on UNITE can be found in our database here

<https://confluence.merging.com/pages/viewpage.action?pageId=86212613>

TOUCHSCREEN AND NAVIGATION

Use the following motions and gestures on your touchscreen to navigate the device.



Swipe from Right to Left on the TFT screen to view the following menus and pages.



Swipe from Left to Right on the TFT screen allows you to return to the previous pages



Swipe Up or Down to scroll through menus or various options



Single tap on the Anubis TFT to select or enable a function/option



1 second

Hold pressed for a period of 1 second to access or modify some parameters. This is required to access the Home page or to open some dialog boxes.

Anubis Rotary Knob



The Anubis Rotary Knob can be used for the Volume control, and to control the Preamps Gain, and parameters such as: Pan, Fader level control, Settings control (Brightness, numeric value entries) and any on-screen rotary control as well as for navigation in various Anubis menus.

Generic: Turn the Rotary knob clockwise to increase values and turn the Rotary knob counter-clockwise to decrease values.



Home Button

Under the Music Mission quickly pressing the pyramid Home button to display the channel rotary view for all Sends. Pressing back will return you back to the Mix page. Cycle back and forth.

Long press the Home button for Settings access.



ANUBIS+MUSIC MISSION

THE CONCEPT

Connect your mic, guitar, keyboard, inserts and make the highest pro-quality recordings in your personal studio or on the road. Benefit from ultra-low latency performance with Merging's DSP mixing engine, built-in effects processing and incredible I/O Specifications.

Based on a Mixing console topology, the Music Mission brings you tons of functionality at the palm of your hand. Not only can you use a full mixer, but since it is totally embedded into the Anubis with its TFT, allows you to fully control it without even the need of a DAW, Tablet or external program.

All this combined with the RAVENNA/AES67 AoIP protocols' support makes your Anubis expandable. Connect another one of those devices over the same network and the Anubis Music Mission will be able to Mix, Monitor and redistribute those I/O locally or over the network back to the added devices.

Who needs the Music Mission?

- Professional Recording Studios
- Project Studio
- Musicians
- Rehearsal/Live
- Producers
- Broadcasters
- Gaming and Installations
- And anyone needing an audio mixer

THE FEATURES

- Realtime processing of Anubis I/O with ultra-low latency engine
- Direct controls from the Anubis TFT
- Internal Mixers - console style – expandable with aggregated AoIP devices
 - 1x Main Mixer
 - 1x Alternate Mixer (multi-functions for monitoring purposes)
 - 3 x Sends (totally Independent)
 - 5 x Cues (totally independent mixers)
 - 2 x Parallel Effects Bus (1 x Reverb and 1 x Dynamics)
 - Built-in Effects: EQ, Reverb and Dynamics
- Mixer controls
 - Level, Pan, Solo, Solo exclusive, Solo PFL, Mute
 - Link, Group, Color, Name, Layout ordering.
 - Any input can be routed to any output
- Mixer features
 - 48 inputs Mixer support (expandable with other RAVENNA / AES67 interfaces)
 - Metering
 - Signal level meter with peak hold, and peak reset.
 - Independent PreAmps metering, Channel Metering and Bus Metering.
- Monitor controls
 - Volume, Reference level, Dim, Mute for every output/bus.
 - Mono Downmix
 - Crossfeed for headphones with Mixer Alternate
 - Flexible Output Routing patch
 - Auxiliary sends in built-in Mixers.
 - 2.1, 2.2 Speakers support and crossover with Mixer Alternate
- Multiple Software Playback DAW's support
 - Stereo DAW (1)
 - Stereo AUXES (5)
- Talkback built-in and control over 5 x cues with latch settings
- All Sends/Inserts can be monitored (wet) and recorded back (wet or dry)
- Merging Built-In plugins
MERGING+EQ, MERGING+DYNAMICS and MERGING+REVERB
- 18 Snapshots to save and recall complete Anubis configuration
- 18 Snapshots/Presets per built-in plugins.
- Peering built-in. Discover other RAVENNA/AES67 devices over your network and integrate those I/O within the Anubis. Control those AD directly from the Anubis PreAmps Pages.
- Various Configuration and Settings options
- Full standalone support and remote control support
- Room correction with Sonarworks SoundID Reference integration.

Missions I/O Channels Specifications

Max channels for	44.1/48 kHz	88.2/96 kHz	176.4/192 kHz	352.8/384 kHz	DXD	DSD64	DSD128	DSD256
Anubis incoming streams	256	256	128	48	48	64	64	64
Anubis outgoing streams	256	256	128	64	64	64	64	64
Anubis+Monitor Sources	128	128	64	32	32	32	32	32
Anubis+Monitor Monitors	32	32	32	32	32	32	32	32
Anubis+Music Input Mixer	48	48	48	24	24	0	0	0
Anubis+Music Output Mixer	24	24	24	24	24	0	0	0

44.1kHz to 192kHz

A total of 48 Strip Channels are supported within the mixer including the peered inputs. The outputs channels are not limited but incoming streams are.

352.8kHz (DXD) and 384kHz

A total of 24 strip channels are supported including the Peered inputs.

Note: The Built-in Reverb, Dynamics, Software Playback (DAW/AUX) and Sends are excluded from those limitations.

DSD

The Music Mission mixer does not support DSD, but allows users to record the direct PreAmps in DSD, monitoring such outside the ANUBIS.

For proper DSD Monitoring it is recommended to run the Monitor Mission.

OPERATION MODES

The Anubis Music Mission includes two operating modes

Default mode

Simplified operating mode, fully operational for an engineer/musician with an additional performer

- Built-in Reverb, EQ, Dynamics with quick rotary control view
- 1 x CUE and 1 x SEND available
- CUE Monitoring controls for 1 CUE
- Fewer menu options
- Fewer configurations and potential setup errors

Expert Mode

More advanced mode, with additional controls and full set of operations.

- 5 x CUES and 3 x SENDS available
- CUE Monitoring controls for all 5 x CUES
- Quick Rotary view display expanded for all 3 x SENDS
- Full Fader view for all SENDS including Reverb and Dynamics Buses
- Mixer Setup Page to customize the mixer channels layout
- Mono Bus Routing support
- Peering support for additional I/O's and quick expansion
- Additional settings such as independent panning for any Mixer

How to enable the Expert Mode

Users can switch to Expert mode within seconds by enabling it from the Settings>Music option.

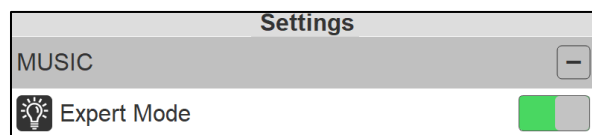

The Anubis top taskbar will show a light bulb as an indicator when the Expert Mode is running



MUSIC MISSION SCHEMATIC

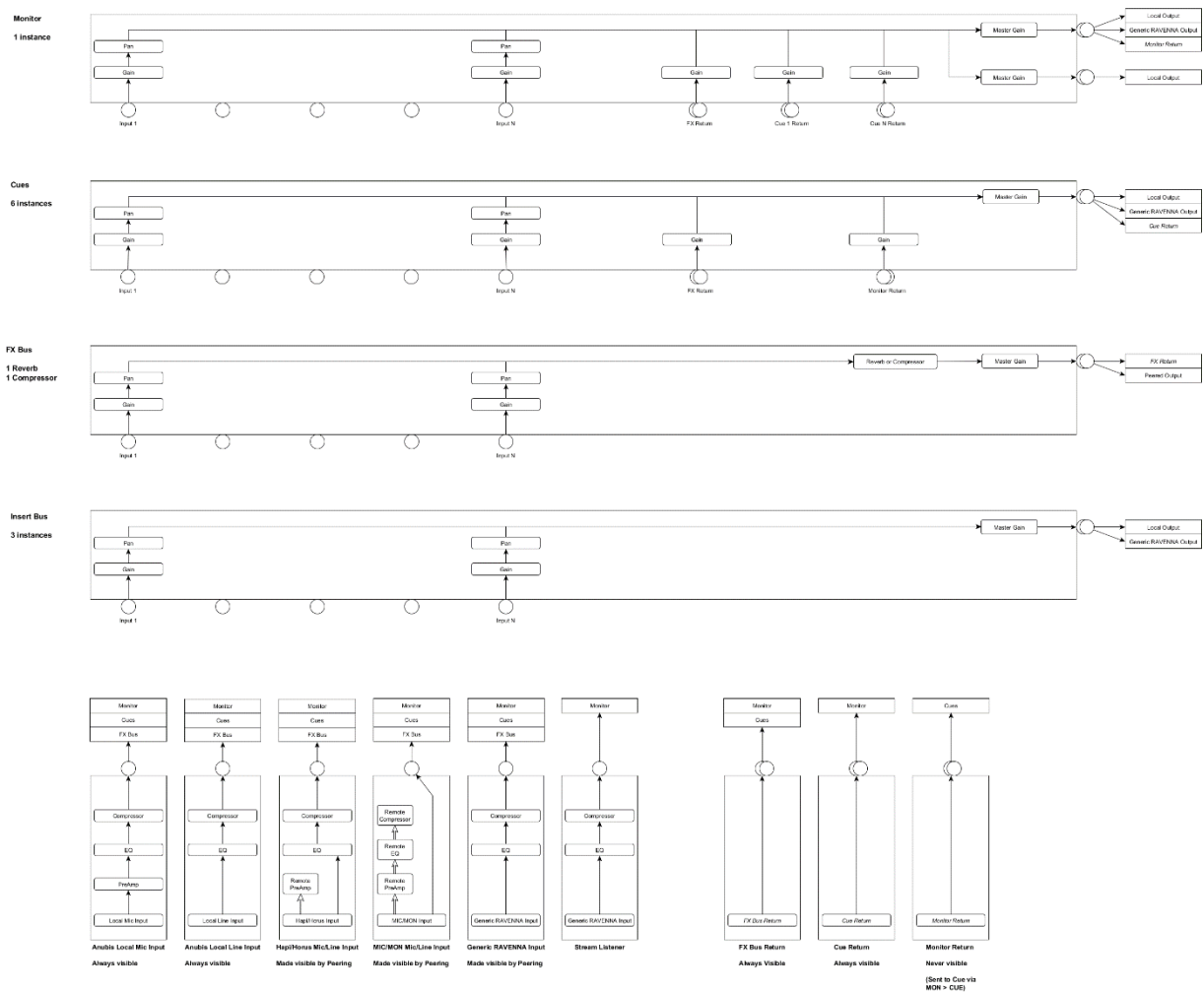

Note: In order to view the same image in a greater resolution refer to the Anubis FAQ image here.

<https://confluence.merging.com/pages/viewpage.action?pagelId=86212659&preview=/86212659/86213167/Music%20Mission%20Schematic.png>

MULTIPLE POSSIBILITIES

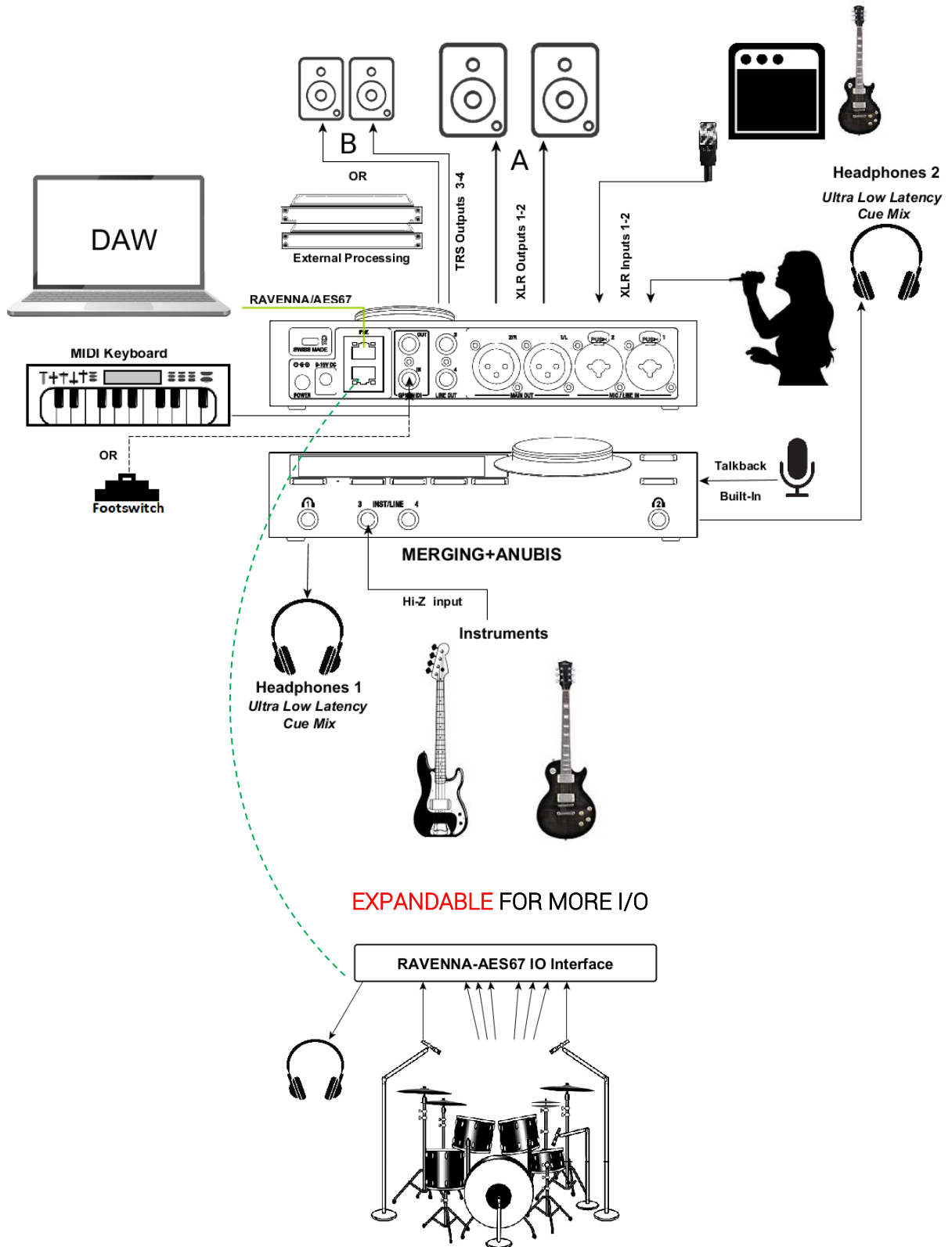

EXPANDABLE FOR MORE I/O

ANUBIS+MUSIC A MIXER TOPOLOGY

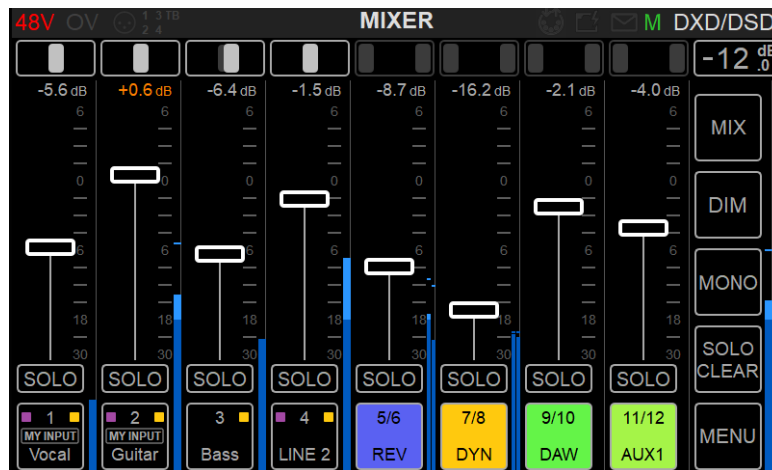

The principal idea behind the Music Mission is to have an audio Mixer console layout view that is familiar. With; Inputs, Buses, Auxes, Inserts, Sends and some monitoring features, generally quite similar to a traditional console-style hardware. The mixer in your Anubis is not much different. With Anubis, you have in your hand a very large mixer, with the Anubis DSP engine power and the RAVENNA AoIP technology, we bring to the user expandable I/O and incredible possibilities.

The MERGING+ANUBIS internal engine includes multiple Mixers which allows you to create one or multiple mixes, using different input sources to different outputs. Those sources can be Physical inputs such as the Anubis PreAmps or inputs from other Merging devices over your network as well as your Software Playback (DAW buses and Auxiliary buses). Those input sources can be routed and/or mixed to different outputs, that are either local physical outputs; such as the XLR 1-2, TRS 3-4, headphones 1 & 2 of the Anubis, or they can be routed and mixed to the outputs of other devices over your network, such as Horus, Hapi or other Anubis.

The Music Mission can be fully used standalone or simultaneously with a DAW for front-end signal processing combined with the Anubis DSP engine for ultra-low latency monitoring and/or tracking. All of the Anubis Mixer processing occurs inside the hardware unit.

In standalone, the Anubis can be used for example as an on-stage mixer. Inputs can be mixed and effects can be applied within the Anubis to its inputs and sent to the Monitor outputs of your choice where you can also apply a Bus EQ or Bus Dynamic. This is expandable using a peered device if more I/O are required. Those additional I/O's can be mixed and routed from the Anubis without the need for any external system (PC or Mac). Mix in the Box from the Box starting today!

THE MIXER

The Mixer page is the Music Mission main page. It is from this main mixer that you can access all of the Music Mission controls. By default, the mixer is preconfigured to operate your Anubis immediately using all its physical Inputs and Outputs and can be quickly configured to integrate your DAW and AUX signals.

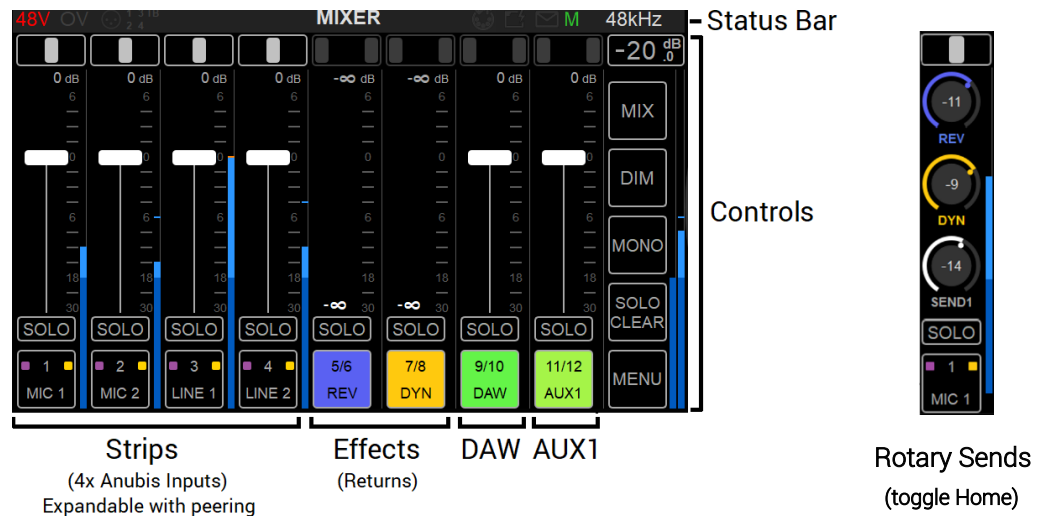

The Mixer Components.

- **Channel Strips:**
Composed of the 4 Anubis physical inputs or the inputs that have been peered from another device (refer to the Peering chapter).
- **Effects Returns Channels**
Built-in Reverb and Dynamics return input channels post effect.
- **DAW-AUXES**
Your system Software Playback. Typically, the DAW Output Bus will be routed in RAVENNA to the Anubis Mixer DAW Stereo Channel. The same applies to the AUX.
- **Additional AUXES and Talkback.**
Some controls are hidden by default, such as more DAW/AUXES and the Talks, those can be displayed from the Menu settings, by selecting the proper SHOW ALL AUX entry.
- **Rotary Sends control view**
Pressing the Home button will display the 2nd part of the strip channel with Rotary Sends view. Toggle the Strip channel view by pressing the Anubis Home button.
Note: When operating in expert mode the cycling will show a second row with 3 x SENDS
- **Expandable I/O**
The Anubis can have more inputs or outputs than those of the Anubis itself as you can peer external devices in order to include more I/O's into your Anubis Mixer. Those I/O once peered are more than can fit on the screen, scroll down to the left to see all of them.
- **The Control Bar**
Access more parameters from the right-side control bar

MIXER LAYOUT

When starting the Music Mission for the first time, you will see the following layout



Inputs Combo 1-2 and Inst/Line 3-4 (Expandable to Peered inputs):

The first channels strips are the four physical inputs of the Anubis. Those Strip inputs represent the physical inputs numbering of the Anubis, starting from the XLR Combo 1 and 2 at the rear of the Anubis, followed by the Line/Instruments Inputs 3 and 4 at the front.

Peer another RAVENNA device input module (A/D, AES, MADI, PT64, ADAT,...), those inputs will follow up the Anubis physical inputs (refer to Peering chapter) and be available in your mixer.

Internal Effects Returns (REV/DYN):

MERGING+REVERB and MERGING+DYNAMICS input returns strips.

Software Playbacks (DAW/AUX):

Lets you route any of the DAW output Tracks/Bus/Aux; it adds them to the Anubis Mixer.

Output Routing (MIX>Bus Routing):

The Music Mission includes multiple Mixers. Ex-factory we route the Mixer Main to the XLR 1 & 2 and HP1 and Cue 1 to HP2 and the Sends 1 to the TRS 3 & 4. The operator can change those routings from the Bus Routing page, route the Mixer Bus to the outputs of his choice, whether they are local or over peered devices.

Strip Channel Layout Diagram

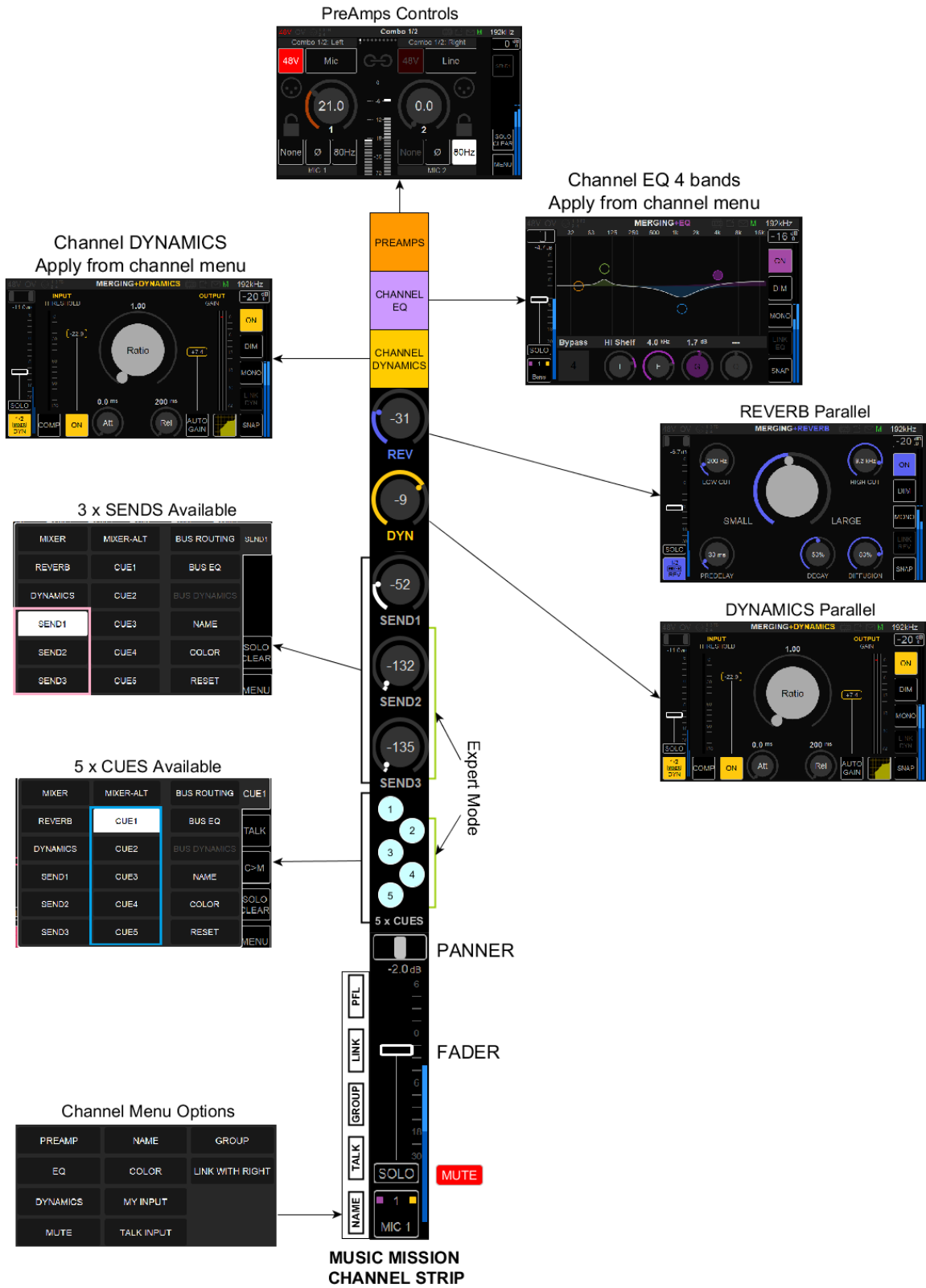

Mixer Channel Detailed

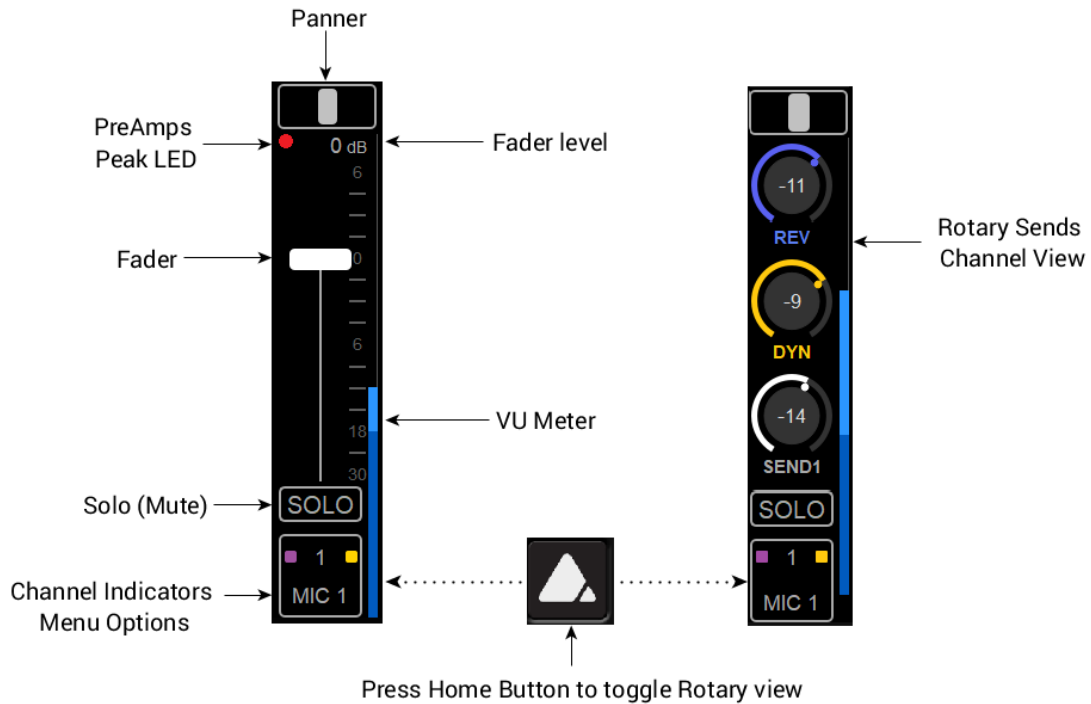

Panner

Tap the panner section in order to open the Strip Panner Window. Drag the bar range left or right to adjust the pan for a channel.

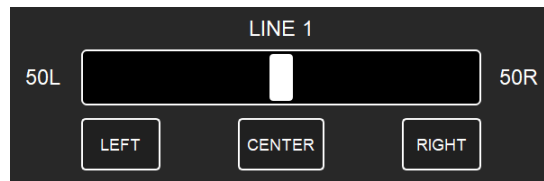

- Tapping **Left** button will pan full left
- Tapping **Center** button will pan to Center
- Tapping **Right** button will pan full right

For precise adjustment either use your finger or the Anubis Rotary encoder. The pan indicator will be fully white filled only when the pan is full left, full right or full center.

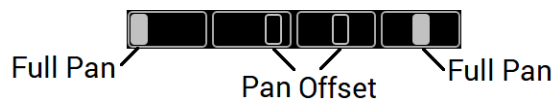

PreAmps Peak LED

A Red LED illuminates fully if the PreAmp input clips. The Peak hold will be displayed as a Red circle. Reduce the PreAmp gain to avoid clipping and reset the Peaks from the Menu "Reset Peak"

option.

Refer to the PreAmps section for all details on the PreAmps page and its peak.

● PreAmps Peak Realtime Hold (Full red circle)

If a peak occurred during a recording or live it is very important to lower the input signal to avoid clipping.

Fader Level (dB)

Numeric readout value of the current fader position

Channel Fader

Use the Fader to adjust the level of the Input Strip signal in the Mix or to adjust the signal of the DAW/AUXES. With your finger select the fader region and move up and down for control, release finger when desired level is reached. The channel fader can be used regardless of where in the range of motion you have dragged the fader.

The default fader value is nominal 0dB while the fader max value is +6dB.

Horizontal Fader control (tap fader to open)

The Horizontal Fader includes additional options and can be controlled by the Rotary Encoder or the on the TFT (tap and move finger left or right)

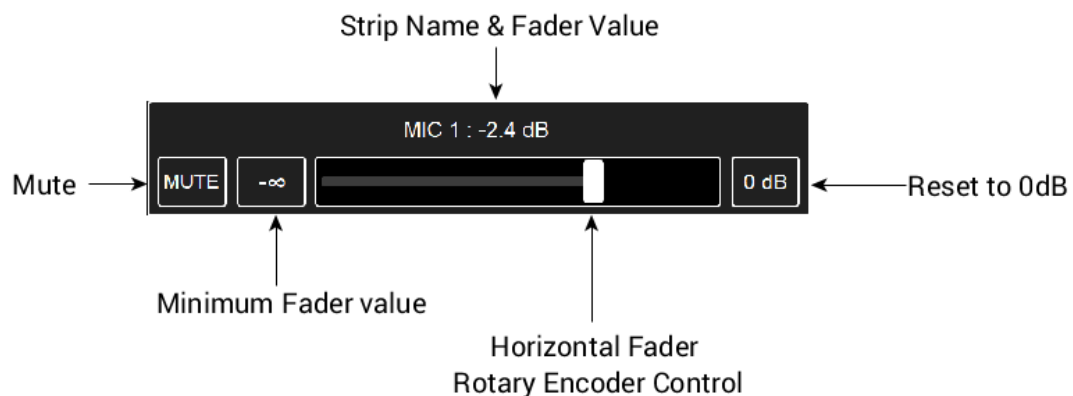

In order to reset the fader to the default 0dB value open the Horizontal Fader view by tapping the 0dB box on the fader section. This will also reset the Peak Hold that was present for that Strip channel inputs

VU Meter

Input signal level meter. It indicates the level coming into the channel. Scaled in dBFS with +6dBFS at the max scale (refer to the DXD/DSD workflow for more on this).

0dBFS corresponds to digital clipping, levels should be adjusted to avoid clipping.

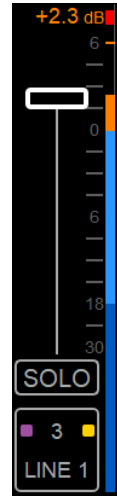
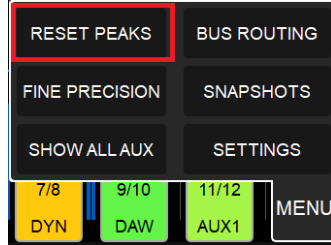

Reset Peak

Peak level display will be indicated in red at the top of the Meters. To reset the permanent Peaks, open the main Menu (bottom right) and select RESET PEAK.

Note: Resetting to nominal level a Strip Channel from the Horizontal Fader will also reset its Peak.

Solo

Tap the Solo button to solo a signal. This will route the channel signal directly to the Monitor Outputs (see Output Routing for details) and will override the signal previously being auditioned

This can be useful for the operator in order to check an instrument inputs being recorded without having all of the other tracks being monitored.

Soloing a strip will not alter the other signal routings and nor will it interrupt the signal being recorded into your application (e.g. DAW).

A Solo Exclusive Option is available under the Anubis Settings, under Music Monitoring> SOLO Exclusive.

When this option is enabled the action of Solo on a selected channel strip will unsolo any other channel strip and will thus only Solo that channel.

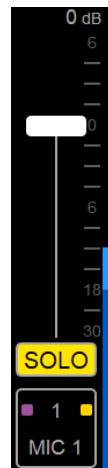

Mute

The Mute option is not on the main mixer UI but it is available in the Horizontal Fader view and in the channel bottom menu. Tap the strip or bus to open the Horizontal fader and then tap the Mute Box to mute the channel signal.

Once the Mute is activated, the solo button in the mixer view will be replaced by a Mute button. Tap on Mute to unmute the signal.

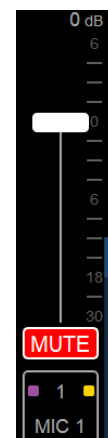

Rotary Sends Channel view

The Rotary Sends view displays the continuation of the strip channel for a quick access to the sends. Press the Anubis Home Button  to toggle between the Fader and Rotary view.

Rotary Channel View (Default mode)



Rotary Channel Second View (Expert mode)



The **Default** Anubis operation mode displays one Rotary row view. In which the Reverb Send, the Dynamics Send and one Send channel are available. Just like a typical console you can adjust the rotary send in order to apply the desired effect level to a chosen channel.

Press Home to Toggle between Rotary and Fader views.

In **Expert Mode** tapping the Home button will show a second view that displays SENDS 1 to 3 along with additional menu options for those controls.

Press Home to cycle through the Rotary views and Fader view.

Channel indications & options

The bottom of each channel (strip and buses) includes indicators and provides access a channel menu that includes various options and controls.

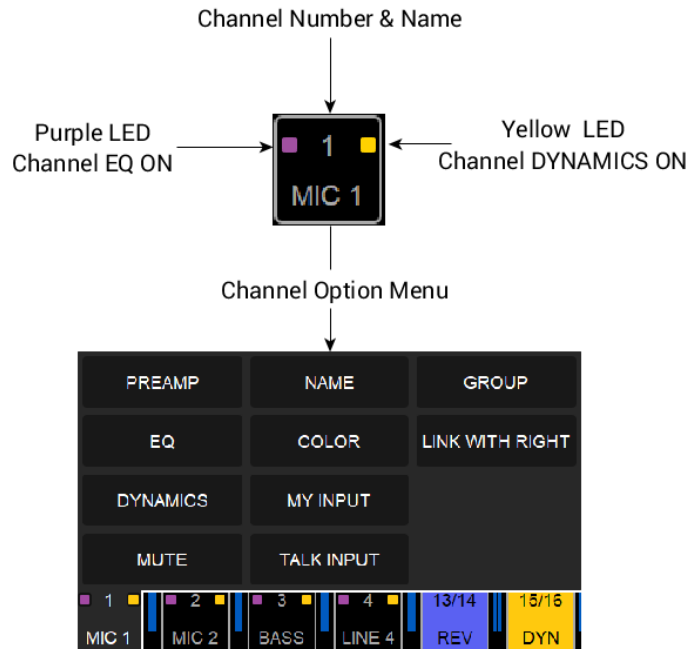

Channel Number & Name

Channel identifier, numbering and name. Renaming a channel is feasible from the Channel Menu option (see below)

LED indicators

Two LED indicators are available



Purple: Will light up If the EQ is engaged for a chosen channel

Yellow: Will light up if the Dynamics is engaged for a chosen channel

Those effects can be accessed from the Channel Menu Options (see below)

Channel Option Menu

Tap the lower channel section in order to open the Channel Menu

PreAmp

Select the PreAmps entry in order to have immediate access to the PreAmps parameters of the PreAmps input channel.

(Refer to the User Manual PreAmps section for all details on the PreAmps page.)

EQ

Enter the channel EQ effect UI in order to apply EQ on a chosen channel, just like you

would on a normal console channel strip.

Note: Refer to the Effect section for more on the EQ user interface details

Dynamics

Enter the Dynamics effect UI in order to apply Dynamics on a chosen channel (Refer to the Effect Section for more details).

Mute

Enable to **Mute** the channel strip. Behaves like the horizontal channel view Mute.

Rename Strip

Give your Channel a custom name for easy identification
e.g Kick, Snare, Guitar, Bass, Vocals, Synth,....

Strip Color

Give your channels a color for easy identification. 8 predefined colors are available

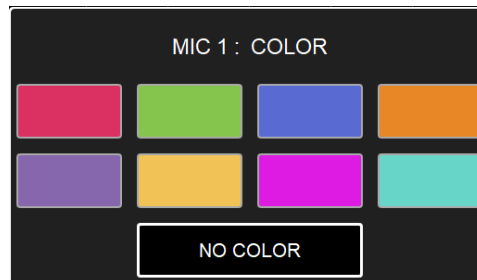

My Input

The “My Input” Identifies the performer’s input and associated Cue. This will link your performer’s input with his Cue, allowing clear identification and some control options.

Procedure: Select first your performer’s mixer (e.g. Cue) and follow up by opening your performer’s input strip menu from which you can select “My input”.

Talk Input

Users have the flexibility to use another talkback input other than the default built-in talkback. Connect a microphone to one of your inputs and configure the Talk Input from within that Strip input option menu.

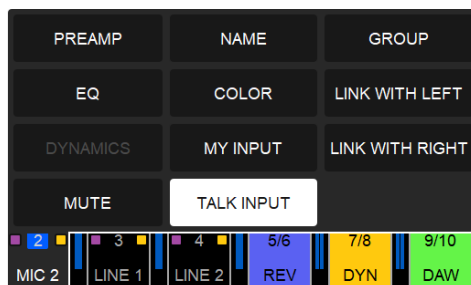



A blue identifier will be displayed on that Strip Channel number, indicating that this strip will now be the Talkback channel. This one will be injected into the cues when the Talk function and button is active.

Group

Use the grouping options to manage multiple channels at the same time or for classification. The group master channel allows you to control levels for all grouped channels while maintaining the same relative level balance between each channel.

In order to create a new group, select the Group entry in the Channel Menu, doing so will open a Group dialog where 8 Groups are available with color choices.



Select the group you wish the channel to be part of. You can add other channels to a group by opening the other channels option menu and selecting the group number in which you wish to add them. The "No Group" option allows the user to remove a channel from a group. Grouped channels are stored in the group master channel.

Clear Group:

Delete a group and its content by selecting the Clear Group option. A dialog will ask your confirmation

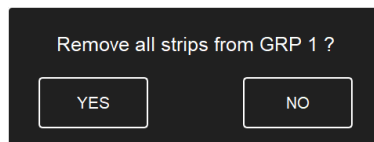

Group Name

Once a group is created, it can be renamed using the Group Name entry

Tap the group icon to show or hide grouped channels. Once a Group is created the operator can have it displayed as collapsed or expanded.

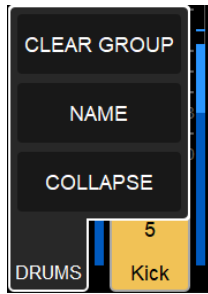

Collapse Group

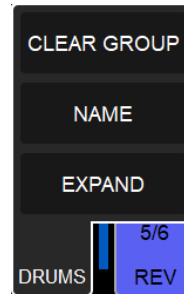

Expand Group

Collapsed view:

The entire group of channels are seen as one channel

Expand view: All channels part of the group are visible with a coloring at top and bottom of the channel section.

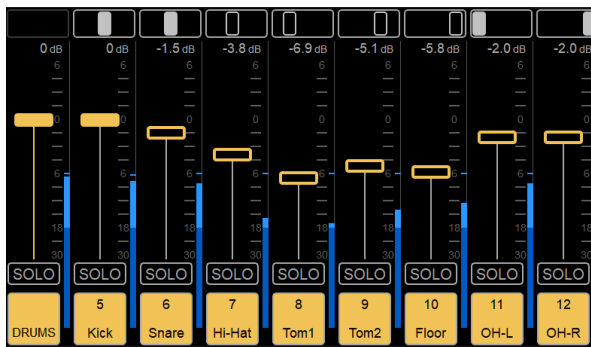

Expanded group view



Collapsed group view

Clear group to remove all channels and delete this group

A group requires at least one strip to exist.

Link / Expand Link

An option to link two channels together is available, with the freedom of panning your channels where you'd wish.

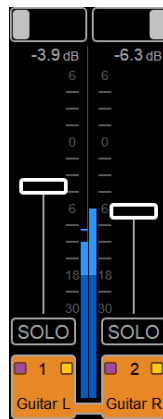

Once channels are linked both VU Meters will be displayed side to side and the channel identifier will be linked. In the example here we have linked a stereo guitar's inputs Left and Right



Linking channels can be very useful in order to apply the same Effect on both channels (e.g. EQ, Dynamics or Reverb). Removing Linked channels from a group will remove both of those.

CUES MONITORING CONTROLS

Located at the far right of the Mixer are the CUES CONTROLS. This provides the Anubis operator a view of all the Cues and their Monitoring controls.

The Default operation mode will show only 1 x CUE and the Expert mode 5 x CUES

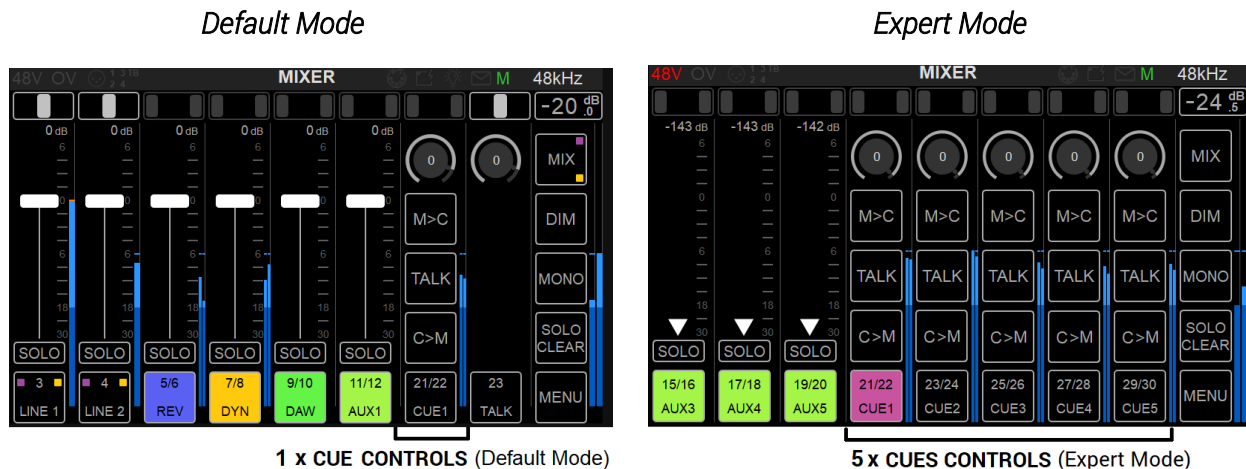

1 x CUE CONTROLS (Default Mode)

5 x CUES CONTROLS (Expert Mode)

Parameters



GAIN (trim)

Access to the Gain level of the Cue Output Routing set for the engineer listen back level control. Will not affect the Cue Performer Monitoring Level.
Range -144dB to +6dB



MON to CUE

When active it will over-route the CUE Mixer by the Main Mixer. MON>CUE is very useful for an engineer to over-route the CUE Mix of a performer in order to have him listen back to his recorded

takes. In such case the DAW Software Playback channels will be injected into the Cue overwriting the performer's AUX. Basically it allows the Musician(s) to listen to the Engineer's mix.



TALK

Activating a talk within a Cue allows the engineer to talk to this Cue when pressing the Anubis Talkback Button



CUE to MON

While the MON>CUE is very useful for an engineer to over-route the CUE Mix of a musician to have him listen back to his recorded takes, the CUE>MON option is the reverse, it allows the engineer to quickly set a balance for the Artist CUE Mix and provides the possibility at any point to monitor what the artist hears. Basically, it allows the Engineer to listen to the Musician's mix.

Note: When a CUE to MON is engaged the SOLO CLEAR button will be replaced by C>M CLEAR on the Anubis TFT. On the Web UI, both buttons are displayed.



CUE Channel Numbering and Option Menu

By default the CUE name corresponds to the CUE mixer in use.

Tap the lower channel section in order to open the CUE channel Menu and refer to the Channel Menu description for more details.

Cue Channels Options

The "Go to Cue" Channel option is a shortcut that will bring you directly to the Cue Mixer if adjustments need to be made to this cue.

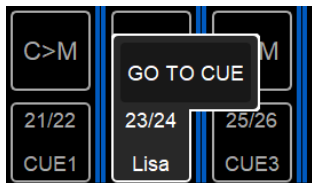

TALK Channel

Provides to the user control over the Talkback channel, levels and panning. Along with the possibility to apply Effects to the built-in Input.

Note: by default routed to the built-in microphone, but the operator can designate a different channel/microphone as the Talkback Mic.



Talk Level

The top parameter is the input Gain of the built-in Talkback and/or additional PreAmps if you use a physical input for your Talkback.



Talk Channel Numbering and Option Menu

Tap the lower channel section in order to open the Channel Menu.



From within the TALK channel you can access the built-in talkback PreAmps, or apply EQ or Dynamics such as a gate to your Talkback built-in Microphone. Refer to the Channel Menu description for more details.



The blue highlighted numbering indicates that the built-in microphone is chosen by default the built-in Talkback Microphone is the TALK INPUT.

MIXER CONTROL COLUMN

The Control column is always visible at the right side of the Mixer. It provides the users with Monitoring elements and as well as functions and menu options

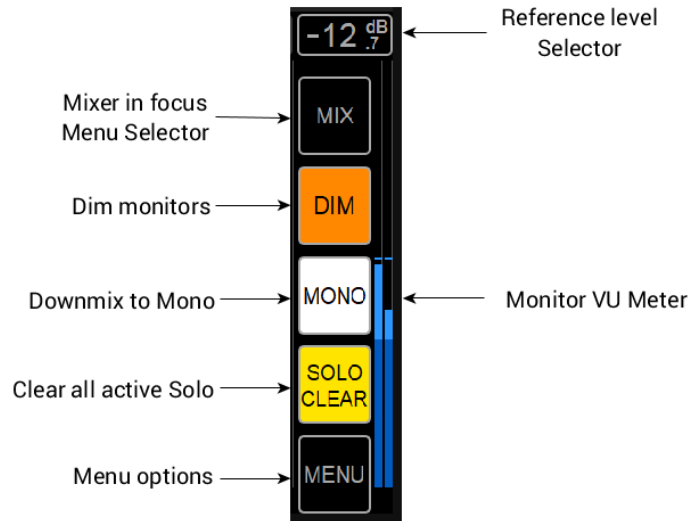

Reference Level Selector

Tap this zone to open the Reference Level fader. Default reference is -20dB and can be set from the Anubis Settings under Monitoring. (Refer to Settings chapter for details).

MIX

Mixer in focus, multiple mixers are available for selection via this button entry. Details below.

DIM

When enabled, the Main Monitor output dimmer is ON, a Dim attenuation is applied to the current volume value of a Speaker Set. The default Dim level is -20 dB and can be configured from the Anubis Settings>Monitoring>Dim Level (refer to Settings chapter for details).

MONO

This option button sums the left and right channels of the stereo monitor mix into a monophonic signal. This can be very useful for monitoring mixes on mono speakers and for checking the phase of input channels.

SOLO CLEAR

Whenever a solo is engaged on a channel the Solo Clear button will light up yellow. Tap the Solo Clear button to deactivate the Solo function of any/all channels. The Solo Exclusive and Solo PFL modes are available from the Anubis Settings>Monitoring (refer to Settings chapter for details).

MENU

Located at the bottom right corner of the Mixer the menu brings to the operator a set of Mixer parameters and options.

REFERENCE LEVEL (Control Column)

Indicates the current reference level of the selected monitor. Tap the Reference box to open the horizontal Reference fader view.

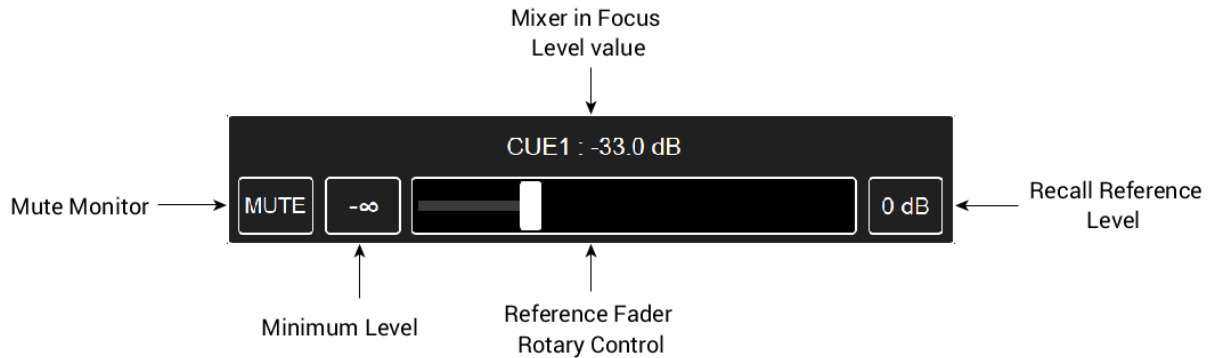

Refer to the Settings section in order to determine the reference listening level you wish to establish when recalled. By default, reference level is set to -20 dB and can be configured from the Anubis Settings>Monitoring where a value range of -144dB to +6dB can be selected.

Mute: Muting the Ref for the chosen Bus will mute this one and this will be applied to the Anubis physical Mute button status as well. The Mute is independent for each Bus.



Note: The Anubis soft button will turn red if muting a Monitor Bus routed to Anubis physical outputs

MIXERS (Control Column)

The Music+Mission brings multiple mixers to the user. Whether he uses only one mixer or wishes to use Cues, Sends or apply Effects, the Anubis user can select which mixer or parameter he wants to operate.

By default the main Mixer is displayed. Configuration settings are available for the chosen Mixer.

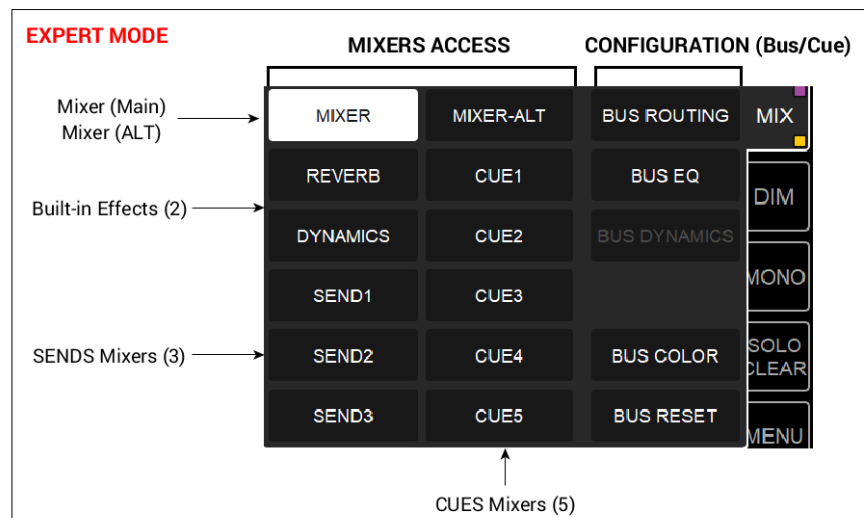
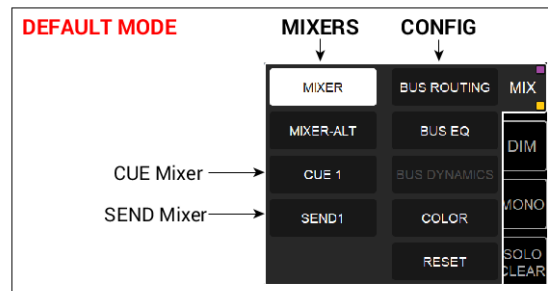

MIXER (MAIN) (1)

Display your Main Mixer, typically the engineer or operator mixer. This mixer can be seen as your main console, with engineering controls and all the required elements to Mix or Record multiple inputs. To configure your Mixer output routing refer to the Menu entry below.

MIXER ALTERNATE (1)

The Mixer Alternate offers multiple monitoring alternatives modes providing support for headphones monitoring, A/B monitors sets, 2.1, 2.2 Speakers layouts support and crossover (sub) along with Crossfeed for all headphones.

This Mixer Alternate is a clone of the Main Mixer and can be routed to another set of outputs, and use a different EQ and Dynamics than the Main Mixer, which is useful if you want the headphones to listen to the Main Mixer while not changing the routing and effects of this one, or if you want another set of Outputs that listen to this same mixer with an independent or fixed volume.

Ex-factory the Mixer Alternate is routed to the Headphones 1 output.

REVERB and DYNAMICS (Parallel)

Control your Effect Sends by opening the Rotary Sends view (tap the home button) and select the Reverb, Dynamics or SEND 1 Rotary, on the channel strip you wish to apply the FX to, use the Anubis rotary encoder to control the send level.

In the example below we are opening the Rotary Sends view and applying Reverb to the Vocal and Guitar. The same can be done in expert mode from the Reverb Sends Fader Mixer view.

Default mode Rotary Sends



Expert mode built-in MERGING+REVERB Sends Faders

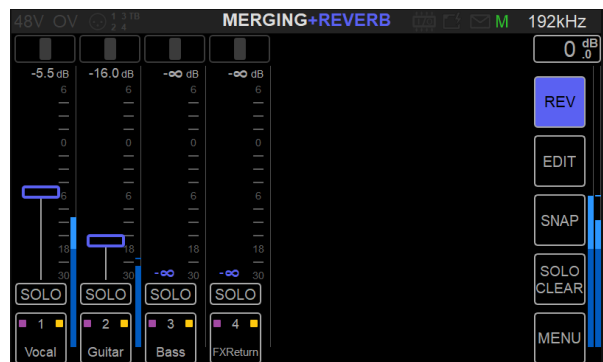

The Reverb view can be accessed from Reverb Return channel Strip



MERGING+REVERB view

Mixer Reverb Return (Dry/Wet)



Make sure that you also raise the Mixer Reverb input return strip to adjust the overall Dry/Wet level.

In Expert Mode within the Reverb Mixer Fader view select the EDIT Button to in order to open the Reverb Page.

The same applies to the Dynamics in order to control your Effect Sends

In the example below, in the Dynamics, a parallel compressor was applied from either the Rotary Sends view or Expert mode Dynamics Sends Fader view.

Default mode Rotary Sends



Expert mode Built-in MERGING+DYNAMICS Sends Faders

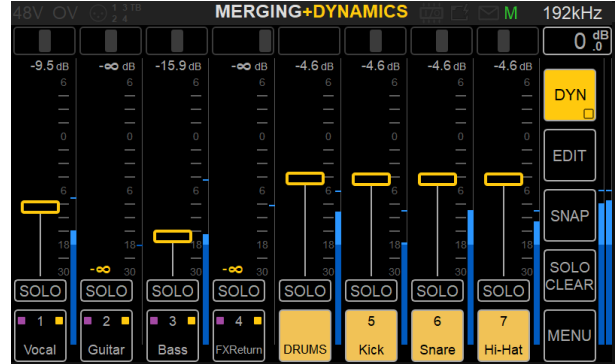

(Refer to the Effects section for instruction on the Effects parameters and controls.)

Note: The Dynamics parameters can be adjusted from the SET/EDIT button and make sure that you also raise the Mixer Dynamics input return strip to adjust its overall level.

MERGING+DYNAMICS view

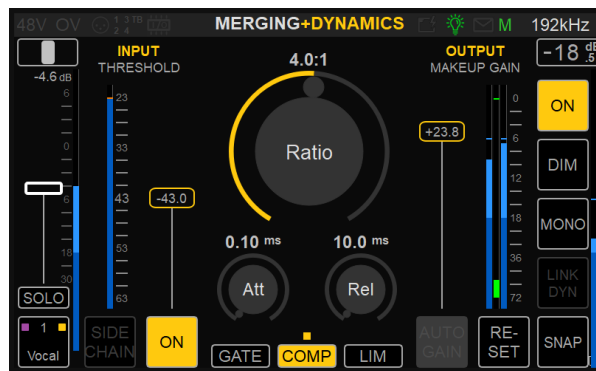

Mixer DYNAMICS Return (Dry/Wet)

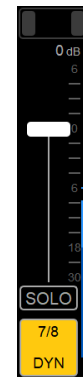

Note: Pre EQ can be applied to the Reverb and Dynamics buses.

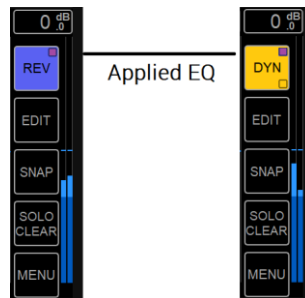

SENDS (3)

The Mixer dialog provides 3 x Sends buses in Expert mode and 1 x Send in Default mode. Those can be used for example with external effect processors. Quickly setup the input and output routing of Mixer sends and control the External Effect sends to the chosen channels.

(To use Hardware Inserts rather than sends refer to the Hardware Insert section in this manual.)

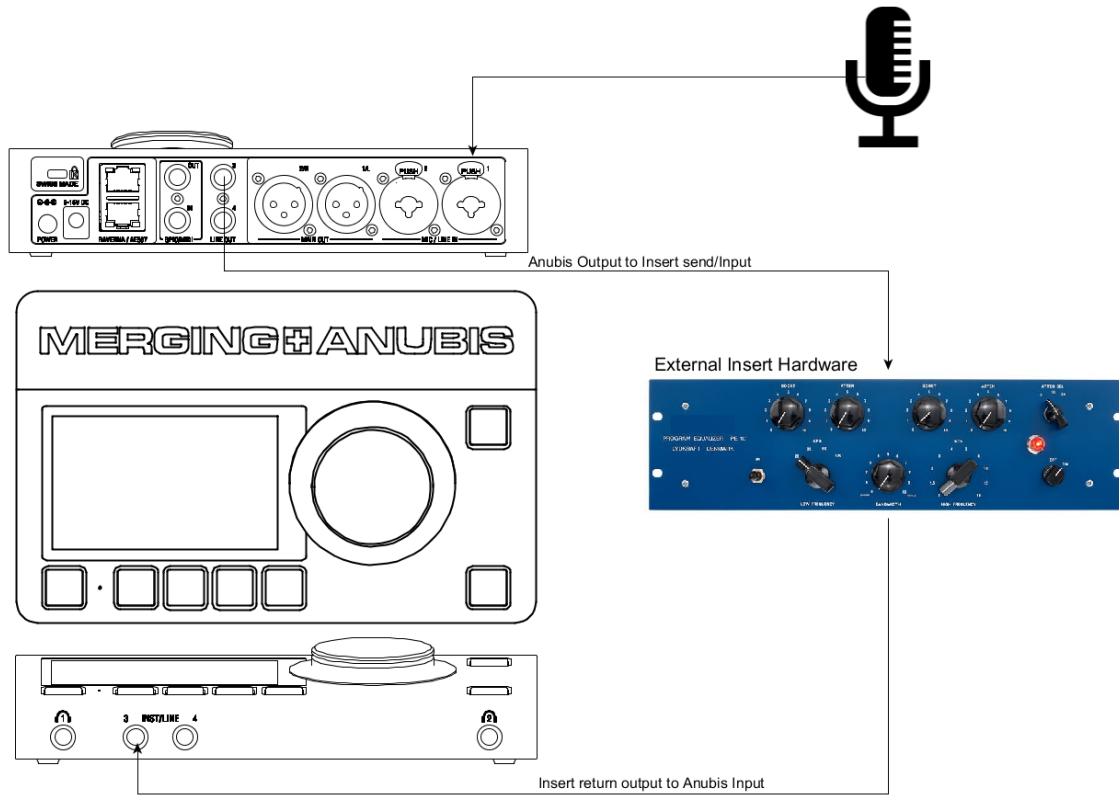

Note. The Anubis Sends can be operated without any routing at the level the DAW.

Sends>Returns Typical scenario:

Connect external analog hardware to inject in the mixers and strip of your choice.

Procedure.

Connect your hardware to one of the Anubis Output, Line Out (L-3) in the example here. This can be performed from the Output Routing Page

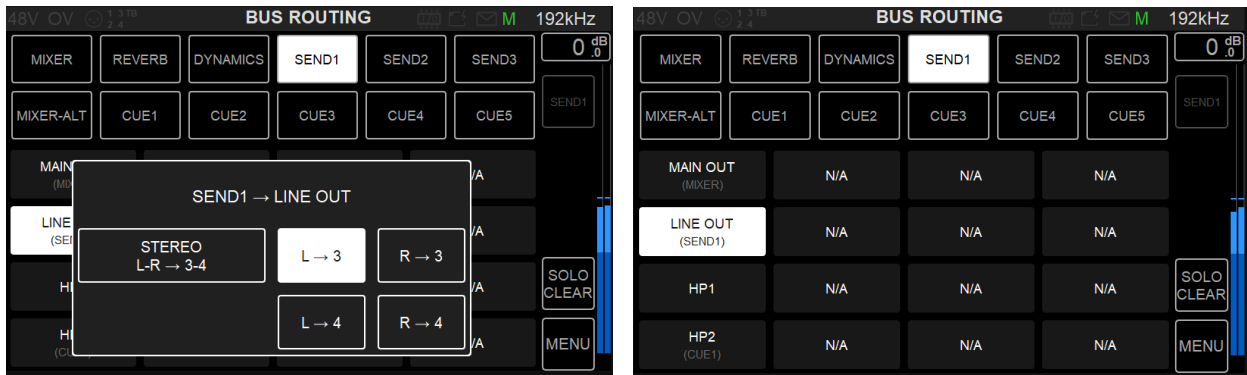

Afterwards connect the External Hardware return to one of the Anubis Inputs, example (Instrument/Line input 3)

Finally open the Send 1 Mixer and decide which channels will be sent through this external hardware by raising their strip level faders.

Important: Mute the Return channel within the Send Mixer to avoid a feedback loop being created and potentially damaging your speakers, or worst your ears!

Sends in rotary view



Sends in Mixer view

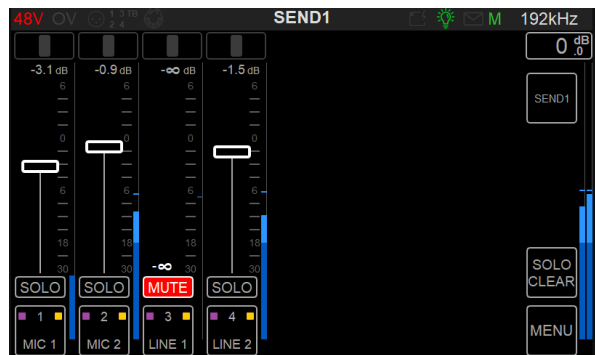

You can now apply the effect to one of your Anubis inputs for example, to the singer voice on Combo input 1 of Anubis.

Note: For stereo external Sends, simply connect channels pairs (e.g. Line Outputs 3-4 & Line Inputs 3-4) and apply proper full Left and Right panning.

To return to the Mixer page, press the Anubis home button.



CUES (5)

The Music Mission includes 5 x Ultra-Low Latency Cue Mixers. Allowing unique mixes that are separated from the main Mixer. Cues are useful to create ultra-low latency FPGA-based effects for the performers' foldback mix.

Note: The default operation mode will show 1 x CUE available and the Expert Mode has 5 x CUES

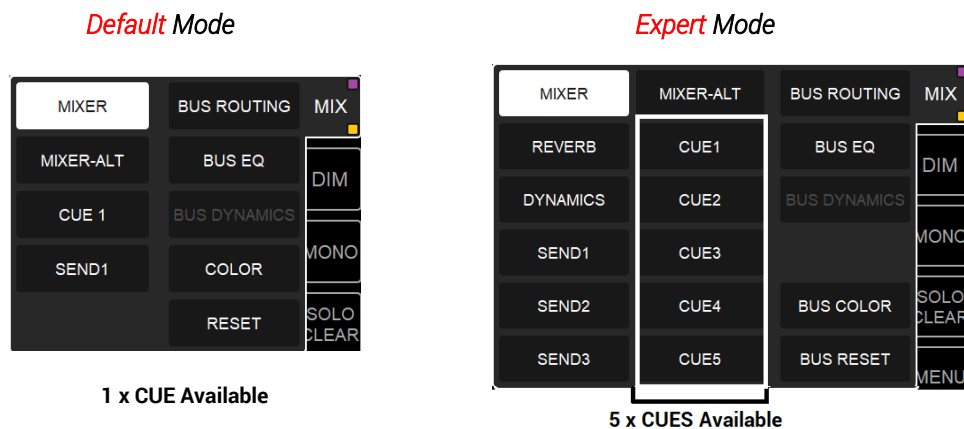

When using Cues the performer's direct input can be mixed with the Aux in the Anubis mix engine during the performance recording, thus benefiting from the Anubis DSP engine to avoid any latency issue. Once the performance/recording is completed, the performer can listen to his performance by using the Anubis M>C (Mon to Cue) features that overrides the Cue Mix with the main Mixer what would normally be monitoring the DAW Mixer outputs.

CUES Operating Modes

Every CUES can operate in CUE mode where you have independent Mixers for each CUE or in Mixer Alternate (MIX-ALT) mode where the Cue Mixer is a replica of the Main Mixer, but will have its own Master Gain and Master Effects.

When in Mix Alternate mode the CUE will no longer appear in the CUE Monitoring section, and its right-side bar controls will be the same as the Main Mixer ones. This mode can be useful in order to Monitor the Main Mix out of different Buses.

Note: The CUE Operation mode can be changed from the Settings>Monitoring page.

Cue Customization

Rename Cues, colorize and Route those to local or peered outputs. (Refer to the Menu Output Routing section in order to route a CUE Bus)

CUE Mixer selector

Select the CUE you wish to configure or use from the Mixer options menu,

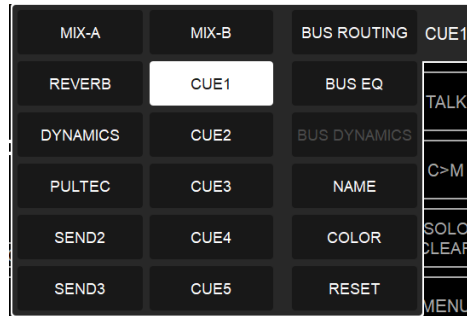

This will display CUE Mixer, where you have a totally independent Mix for the chosen CUE.

CUE 1 Mixer Fader display

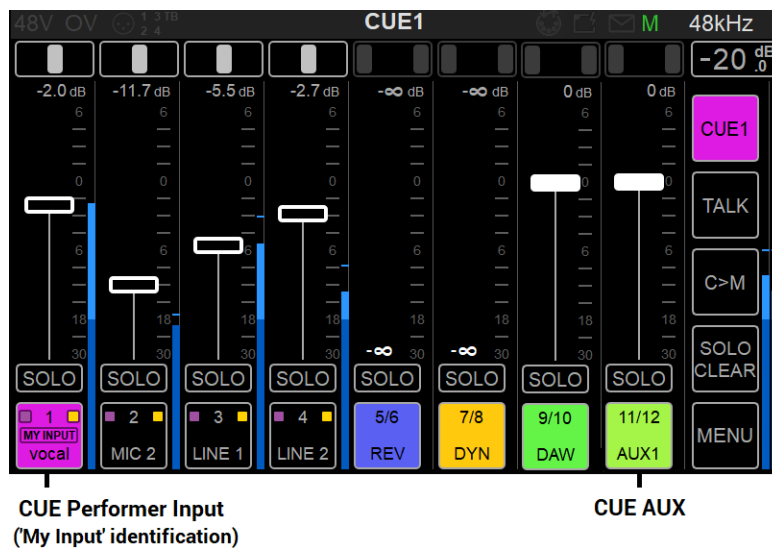

CUES Display Layout

Cues are typically used for performers who want to hear a different mix than the Main Monitor Mix, more than often a Cue Mix will be composed of the performer's direct input signal that would be mixed with a DAW Aux bus that will not include this instrument input as this is taken from the direct input. The layout is then composed of an independent AUX by default for each CUE.

- Cue 1 -> Displays AUX 1 in available Software Playbacks (DAWs)
- Cue 2 -> Displays AUX 2 in available Software Playbacks (DAWs)
- Cue 3 -> Displays AUX 3 in available Software Playbacks (DAWs)
- Cue 4 -> Displays AUX 4 in available Software Playbacks (DAWs)
- Cue 5 -> Displays AUX 5 in available Software Playbacks (DAWs)

SHOW ALL AUX (Column Menu)

This option can be used in order to display all DAW Software Playback in the mixer. To be used if you would wish to change the Default CUE and AUX Mixer assignments.

CUES Monitoring Controls

This view allows the engineer to have all the necessary controls in order to prepare the artist cues, monitor them back, override their monitoring with the recorded take (DAW Playback) and to talk to all Cue or individual Cues.

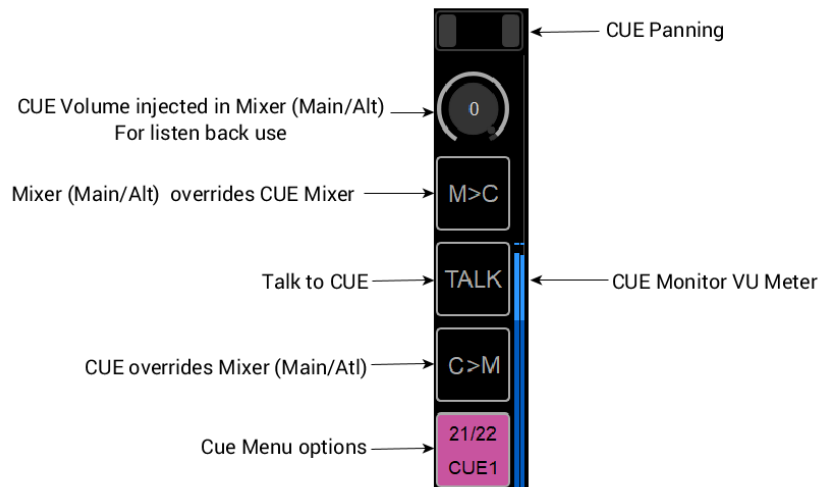

Within a Cue, the Control Column view changes and displays the Cue monitoring controls. So that the engineer can still talk to the Artist and as well as listening to his Cue and prepare the artist mix.

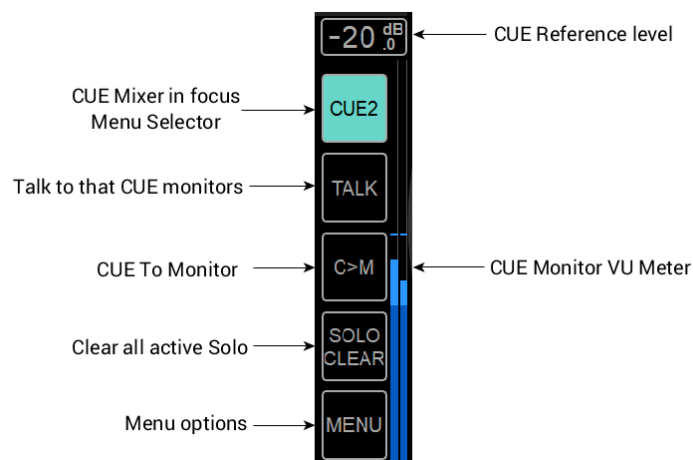

Cue to MON engaged

When a CUE to MON is engaged the Solo Clear button will be replaced by the C>M indicator. Warning the operator that he is not monitoring a Cue.

The default operating mode will display 1 X Cue Control Channel, Expert mode shows 5.



My Input

The “My Input” identifies the performer’s input(s) and related Cue. This will link your performer’s input(s) with his Cue, allowing clear identification and some controls options. The performer can have multiple inputs defined as “My Input” for his Cue.

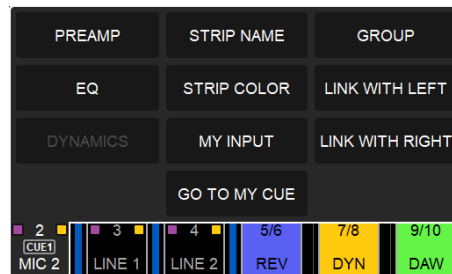

Go to My Cue

Channel option is a shortcut that will lead you to that Cue Mixer. All inputs set as “My Input” offer a direct “Go to Cue” menu option.

IMPORT MIXERS

Import a mix balance from any mixer you have currently. This allows a quick and efficient workflow if you have multiple CUES and want those to start from the same mixer setup.

How to Import Mixers

1. Be on the Mixer/CUE you wish to import to

In the example here we wish to import into CUE 3 the CUE 1 Mixer

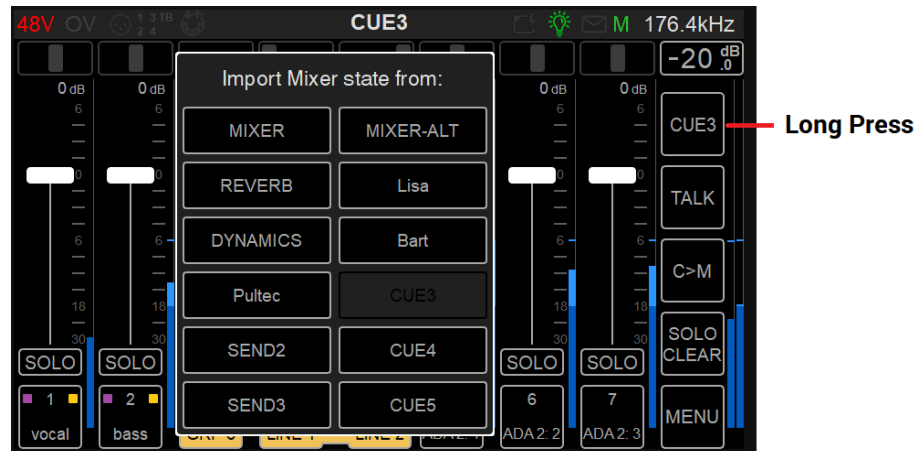

2. Long press the CUE button (2 secs)

3. This will open the Import Mixer dialog

4. Select the Mixer you wish to import.

This will overwrite your current CUE Mix with the imported one.

Cues Set Up Example:

Singer and Guitarist each have their own ultra-low latency Cue Mixers and each of their cue inputs were identified using the “my inputs” strip option (refer to the Strip Channel option menu).

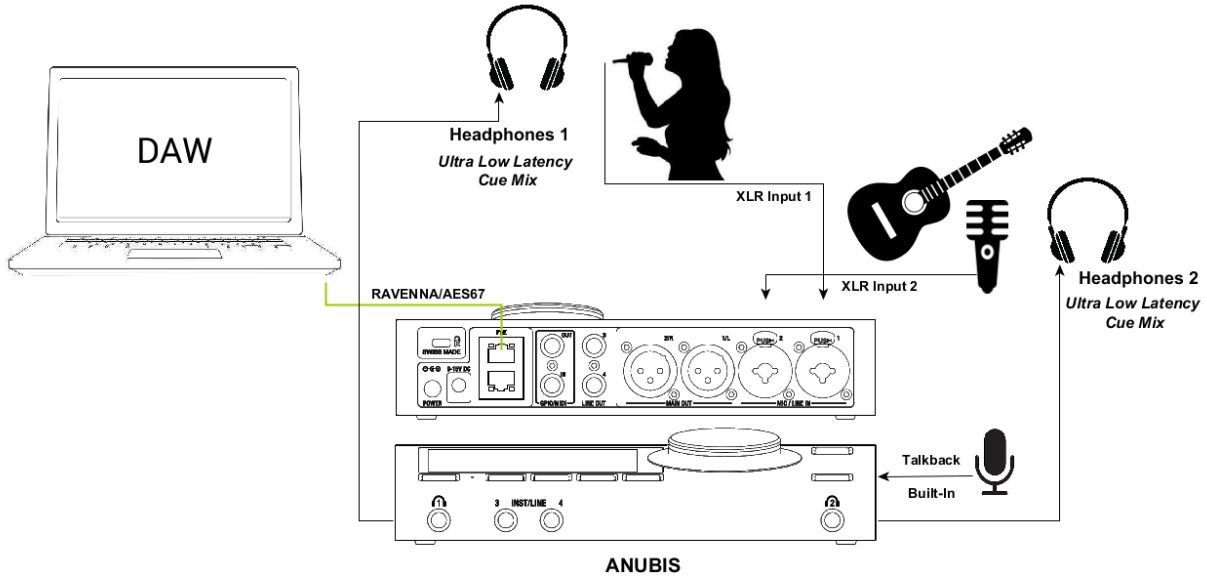

Each performer will have their own Cue Mixers.

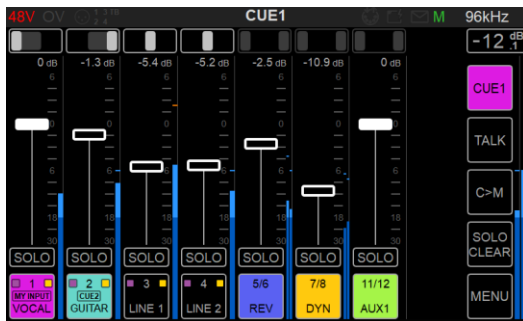

CUE 1 Mixer - Vocal (performer)

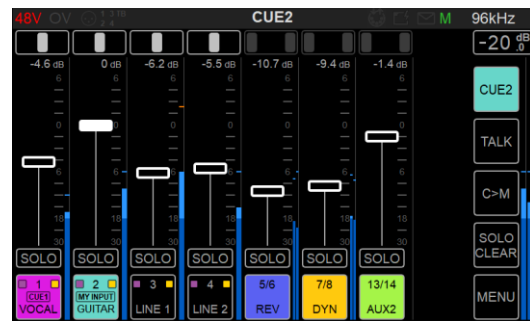

CUE 2 Mixer - Guitarist (performer)

The Bus Output Routing will have CUE 1 to HP1 and CUE 2 to HP2

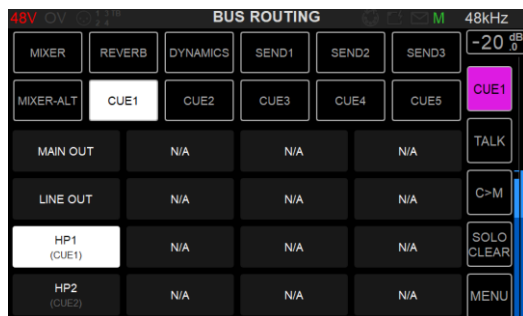

CUE 1 Routed to HP1 - Vocal (performer)

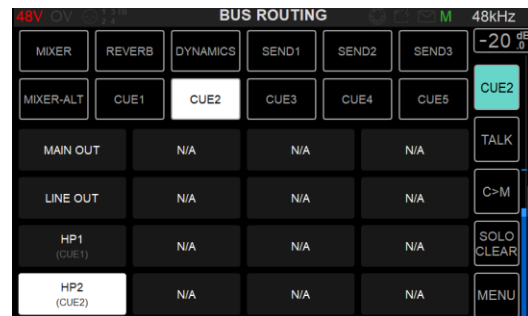

CUE 2 Routed to HP2 - Guitarist (performer)

BUS PARAMETERS

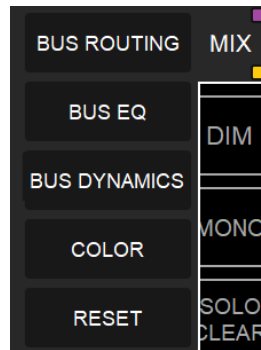

BUS ROUTING (Mixers Menu)

BUS ROUTING

The Bus Routing configuration is available from the Mix Configuration dialog and the Menu options, both will redirect the user to the same Bus Routing configuration page.

Configuring your Bus routing is fundamental in order to patch the outputs of each Mixer Bus and in order to monitor your Mixer, Sends or Cues.

Note: The Default Operation mode will display a reduced set of Buses available, switch to Expert mode for extended possibilities.

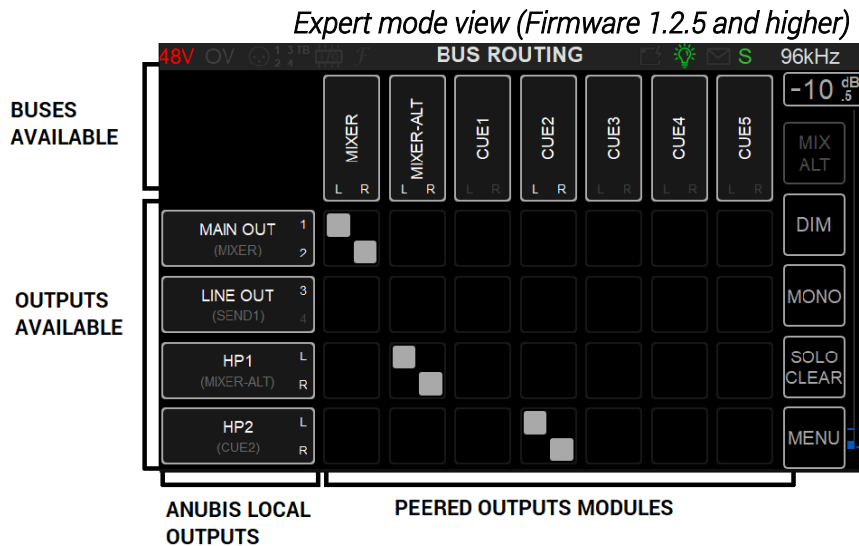

If you have peered other devices output modules with your Anubis then those will be listed in pairs and available for routing. The peering options are only available in Expert mode.

Note: If a Bus routing is performed to local physical Anubis outputs, the Anubis soft button will light up, it will also follow the Bus colouring if you customize the Bus colour.



How to configure the Bus Routing.

Mixer Buses are available listed in the first rows of the Bus Routing dialog. Tap the Mixer Bus you wish to patch, this one will become highlighted in white.

Default mode Bus Routing



Expert Mode Bus Routing

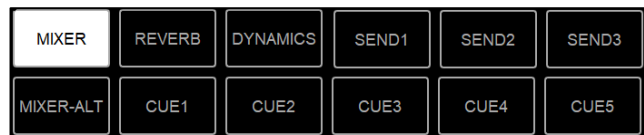

Afterwards tap the output set you wish to patch your Bus to. A dialog will open from which you can select the outputs you want to use, if you did not peer another device with Anubis only the local sets of outputs will be available.

Legacy (firmware 1.2.4 and prior)

MAIN OUT (MIXER)	N/A	N/A	N/A
LINE OUT (INSERT1)	N/A	N/A	N/A
HP1 (MIXER-ALT)	N/A	N/A	N/A
HP2 (CUE1)	N/A	N/A	N/A

New Bus Routing (Firmware 1.2.5 and higher)

MAIN OUT (MIXER)	1	<input checked="" type="checkbox"/>							
	2	<input checked="" type="checkbox"/>							
LINE OUT (SEND1)	3								
	↓								
HP1 (MIXER-ALT)	L		<input checked="" type="checkbox"/>						
	R		<input checked="" type="checkbox"/>						
HP2 (CUE2)	L			<input checked="" type="checkbox"/>					
	R			<input checked="" type="checkbox"/>					

The route channels selected will be the highlighted in white. Ex-factory the routing is such.

- Mixer (Main) -> Anubis Main Out XLR 1 & 2
- Mixer-Alternate-> Anubis Headphones 1
- CUE 1 -> Anubis Headphones 2
- Send 1 -> Anubis Line out TRS 3 & 4

To configure your Bus routing tap the Output pair you wish to route to. This will open the routing dialog from which you can route in Stereo or in Mono or can flip the Stereo routing.

Note: Mono routing and the inversion of Stereo channels are only supported in Expert mode.

Routing Patch Dialog (expert mode only)

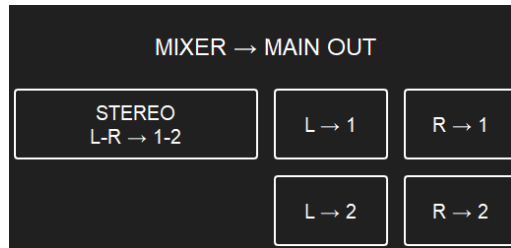

- Stereo L-R -> 1-2: Routes the Bus to the Stereo Channel Pair (1-2) of the Anubis
- L -> 1: Route the Bus to the Left channel to the Anubis (out 1)
- R -> 1: Route the Bus to the Right channel of the Anubis (out 1)
- L -> 2: Route the Bus to the Left channel to the Anubis (out 2)
- R -> 2: Route the Bus to the Right channel of the Anubis (out 2)

Bus Routing Examples

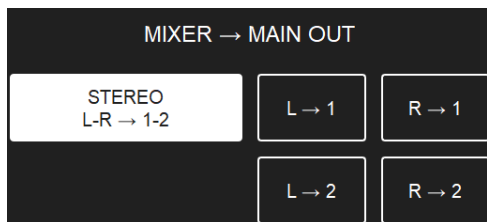

Mixer Main: Routed to Anubis XLR Outputs 1-2



Send1: Routed to Anubis TRS Outputs 3

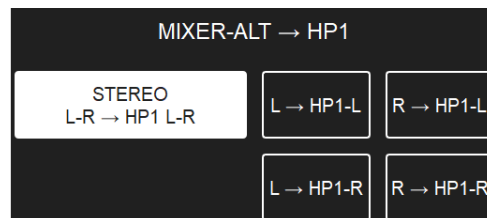

Mixer ALT: Routed to the Anubis HP1 (1-2)

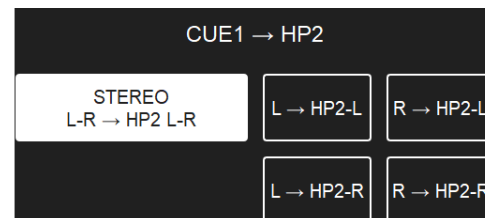

Cue1: Routed to the Anubis HP2 (1-2)

Once your routing has been performed, the output section will indicate the Mixer Bus in use.

Note: selecting the L-1 and L-2 will select one or the other, for such patching simple select Stereo

MAIN OUT (MIXER)
LINE OUT (INSERT1)
HP1 (MIXER-ALT)
HP2 (CUE1)

Main out (1-2) is connected to MIXER

Line out (3-4) is connected to SEND 1

Headphone (1) is connected to MIXER ALTERNATE

Headphone (2) is connected to CUE 1

Warning: Routed output channels cannot be used twice. Once a routed channel is routed it cannot be used by another Mixer bus, re-using it would disconnect it from the Bus where it is in use.



To return to the Mixer page press the Anubis home button.

BUS EQ

Access to the Anubis BUS EQ, that can be applied to your selected bus (user choice). (refer to the Effect section for more details.)

Built on the existing and universally acclaimed quality of the Pyramix EQ-X and offers Extreme definition filtering at sampling frequencies up to DXD.

BUS DYNAMICS

Access to the Anubis Dynamics. (Refer to the Effect section for more details.)

BUS (CUE) Color

Give a color to your Mixer for easier identification.

Selecting the Color entry will open an 8 color palette, picking a color to colorize the Mixer selected.

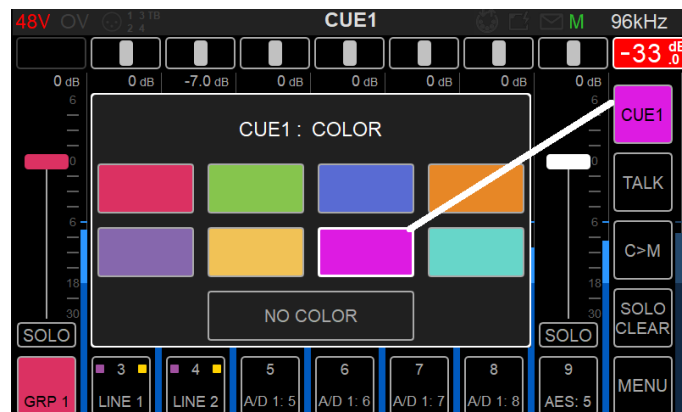

RESET

Selecting the Bus Reset will re-initialize the mixer in focus (selected).

- All Faders will be reset to 0dB

- Pans are reset to center

- Solo/Mute are reset to disable

- Bus Monitor Level and Master Effects are not reset; they remain to the last set values.

MENU OPTIONS (Control Column)

Located at the bottom right corner of the Mixer, the menu offers a set of Mixer parameters and options to the operator.

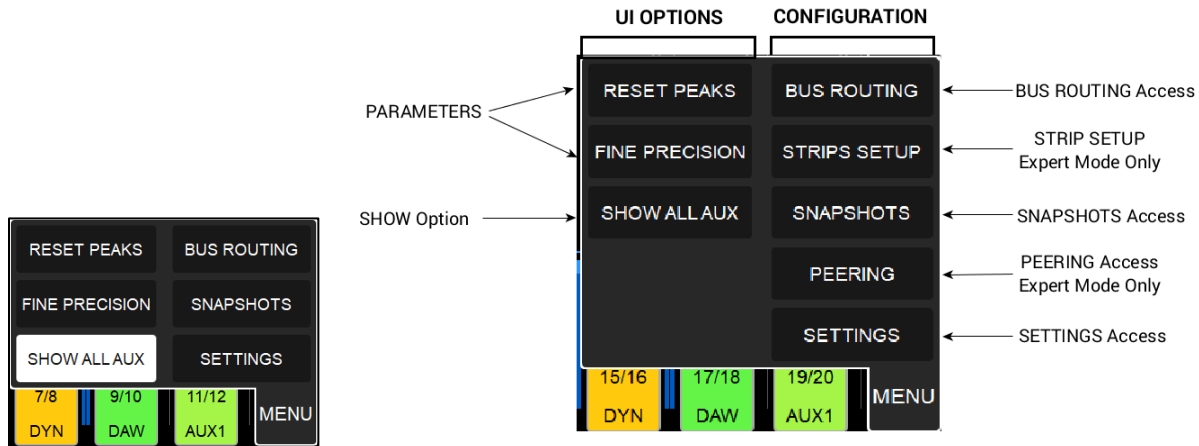

Default Mode

Expert Mode

RESET PEAKS

Select the Reset Peak to reset the Meters Peaks hold on the Mixers pages.

FINE PRECISION

Sets the sensitivity of the fader range. For smooth and precise Fader movement adjustments enable the Fine Precision option.

This entry toggles between Normal Precision and Fine Precision, it will only affect the Faders.

When active an **F** will appear in the Anubis Taskbar

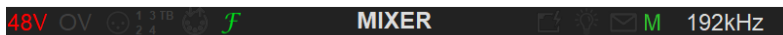

Fine Precision
Enabled

SHOW ALL AUX

Enable to Show an additional 5 X AUXES (e.g. software playback).

By default, only 1 DAW and 1 AUX are displayed.

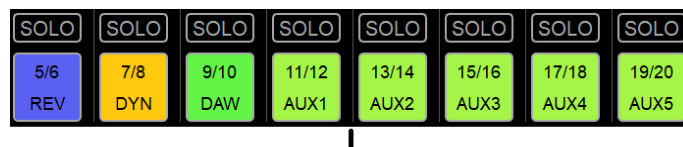

Additional DAW AUXES

STRIPS SETUP

The Strips SetUp feature is only available when running in Expert Mode and will allow the operator to Setup the mixer in order to move strips and organize the Mixer Strips layout.

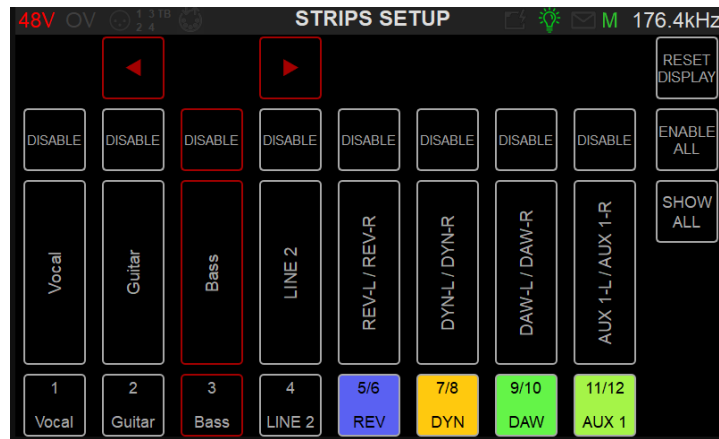

To move strips, select the channel you wish to move. This one will be highlighted in red and two arrows will appear so that the channel can be move to right or left.

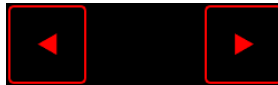

Tap the arrow towards the direction to where you want to move the strip.

Note: Only one arrow appears if the strip channel is already at one of the extremities of the mixer (first or last).

Grouped channels can all be move simultaneously if selecting the Group Master or can be moved individually if selecting channels within the group.

Reset Display

Will reset the strip order layout to the default Strip order (Local inputs followed by Peered inputs)

Enable All

Enable all the strips, use this action to enable all strips that were disabled, upon confirmation.

Show All Strips

Option to show in the setup page the disabled Strips, those will be shown in order to move them.



Once you have completed your Strip SetUp ordering, exit the page using the Anubis home button to apply the mixer layout changes.

SNAPSHOTS

18 snapshots are available within the Anubis Music Mission.

Save and recall your Anubis settings whether they are; sessions, songs, mixers, mastering sessions, live set lists and add comments to those.

Recall a Snapshot will recall the entire Anubis configuration.

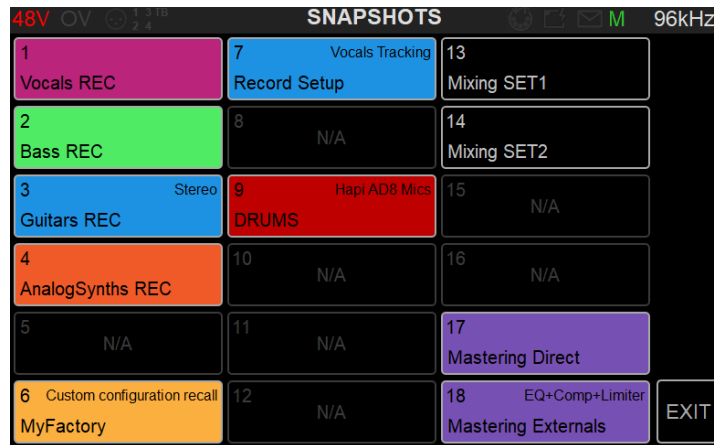

Tap and empty (N/A) snapshot entry in order to open the Snapshot dialog.

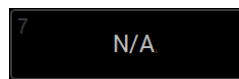

The Snapshot dialog allows the user to define the snapshots name, comments, color and store the snapshot preset.

Name and Comment are editable text fields, that will open the keyboard if selected.

The Color, Store, Update and Delete entries are buttons acting at selection.

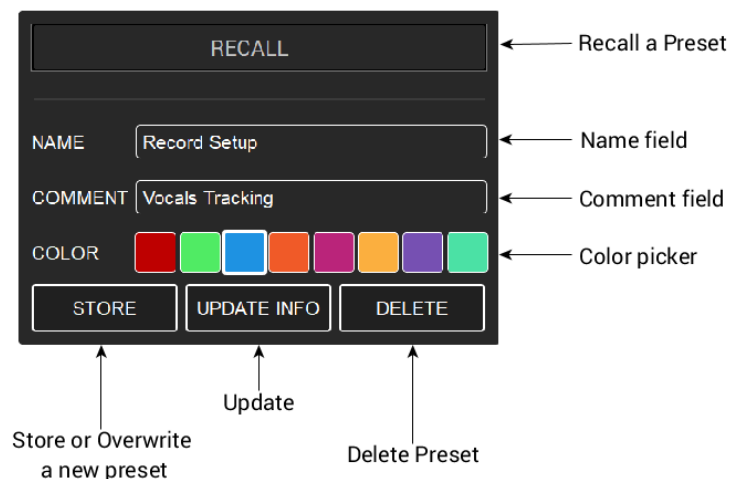

Load and manage your Snapshot using the functions; recall, update or delete.

Selective Snapshot Recall (as of Firmware 1.2.5 and higher)

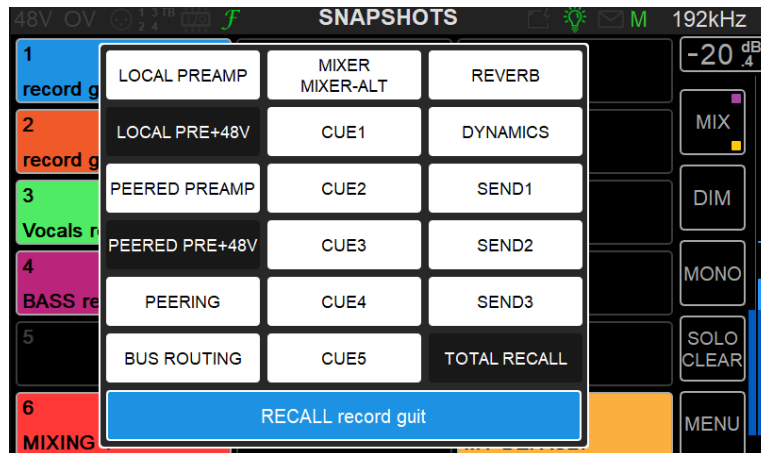

Enable in white the elements you wish to recall in your snapshots.

Local PreAmps: Recall the PreAmps parameters of the Anubis itself.

Local Pre+48V: Recall the PreAmps PreAmps and +48V status of the Anubis itself

Peered PreAmps: Recall the Peered PreAmps parameters of the Peered device

Peered Pre+48V: Recall the Peered PreAmps and +48V status of the Peered device

Peering: Recall all the Peering IO devices

Bus Routing: Recall all the Bus routing matrix patching

MIXER & MIXER-ALT: Recall the entire Main Mixer status (faders, pan, effects, groups, links,...)

Cue 1 to Cue 5: Recall the selected CUE Mixer status

REVERB: Recall the Reverb effect status

DYNAMICS: Recall the Dynamics parallel effect status

Send 1-3: Recall the selected Sends parameters

Total Recall

When selected and applied the entire Anubis configuration will be recalled along with all the Anubis Settings as well.

Note: Only the Total Recall will load back the Snapshot saved Settings.

PEERING

Devices	Modules	Inputs	Outputs
Hapi_90003	AES 1	1-8	1-8
	AES 2	1-8	1-8
	AES 3	1-8	1-8
Horus_80064	A/D 1	1-8	n/a
	A/D 2	1-8	n/a
	D/A 3	n/a	3-4

When running the Music Mission the Peering option is available when in Expert Operation Mode (Settings>Music>Expert Mode enabled). In the bottom right Menu select the Peering entry

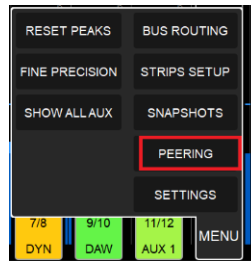

Peering is also accessible from the Anubis Home page at all times.

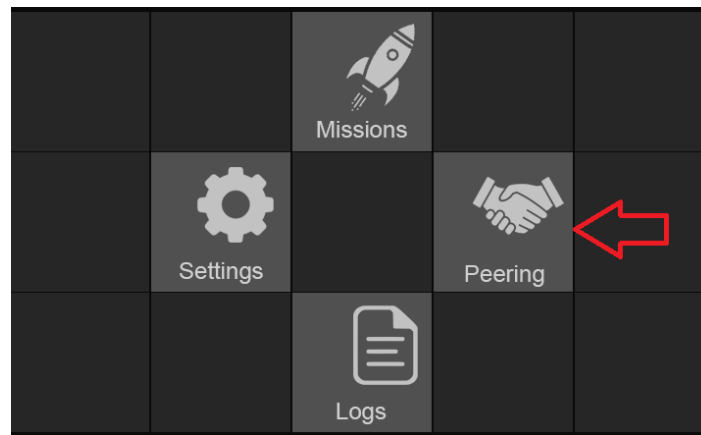

The Peering allows the Anubis to discover Hapi, Horus or another Anubis given that they are on the same network. From within the peering page, a user can select the I/O module to be used (AD's, AES, MADI, ADAT...). The Anubis is then immediately extended and has more I/O available that can be mixed, outputted and controlled by Anubis, exactly as if they were internal I/Os.

Note: Peering does not require a computer system (PC/Mac) to be defined, it can be performed with two standalone devices.

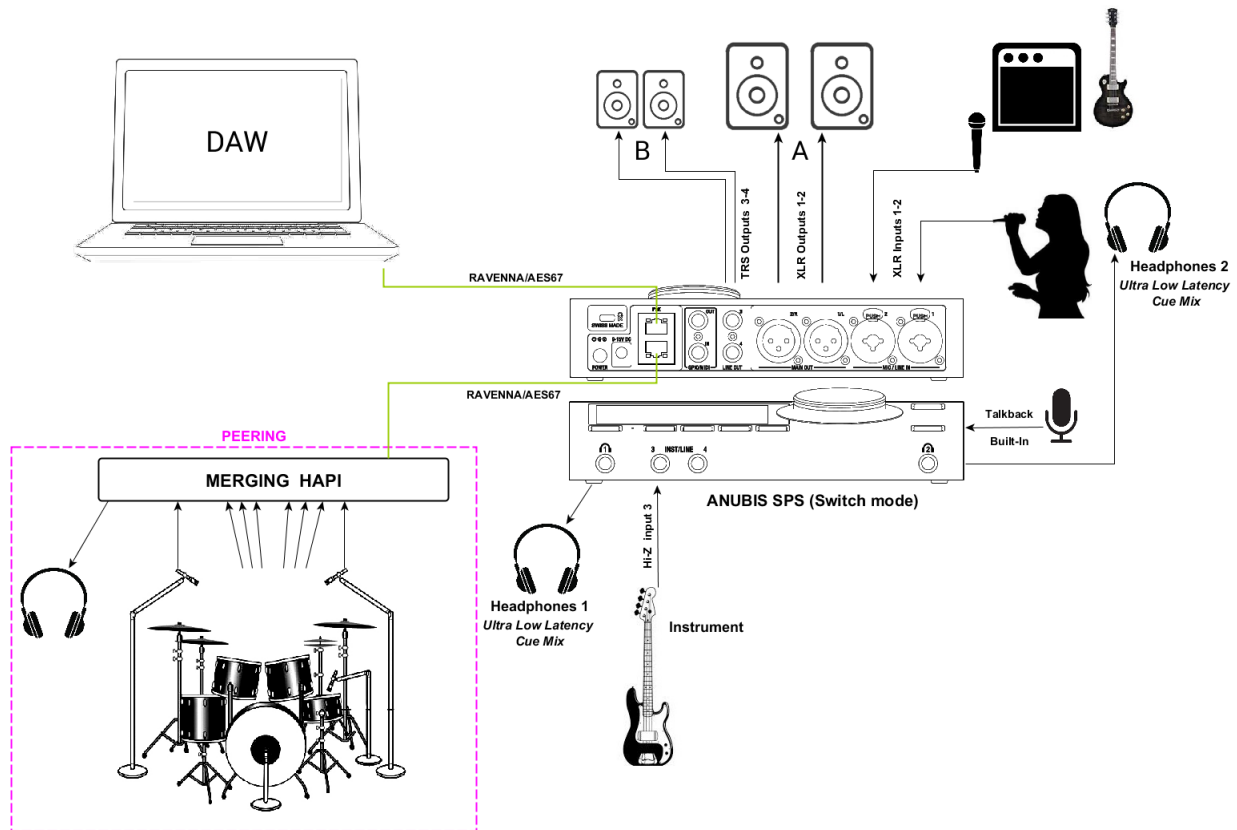

Setup example: Merging Hapi has been peered in Anubis, so that a Hapi AD Module (PreAmps Drums Mics) are mixed within the Anubis ultra-low latency engine, thus in the performers' Cues. The Headphones of the Hapi were also peered so the Drummer could have his CUE provided by Anubis.

Peer to Expand the Anubis I/O

Quick way to easily increase the Anubis I/O without having to use external system (PC or MAC) and applications such as ANEMAN.

As long as those devices are from Merging and given that they are on the same RAVENNA network, you will be able to discover and peer those devices modules from Anubis.

Peer to Mix the IO for inputs or Output re-distribution

The Musician ultra-low latency Cue mixes will require Peering so that inputs from another device can be mixed within Anubis with ease. Once you have peered an input module from another device, this one will appear in the Anubis Mixer view, where you will be able to mix those inputs within the Anubis and be able to route them to the outputs of your choice, either local to Anubis or back to the output of the device (e.g. Hapi), in this case having peered outputs is needed.

Application Example: Anubis is peered with a Hapi that is setup with 8 Mics on a Drum, those 8 Inputs are mixed in a headphone Cue for the bass player, going through the Anubis ultra-low latency Mixer Cue. Those drums' peered channels can be adjusted to the level preference of the bass player and mixes along with the bass input channel that would be coming into one of the Anubis instruments inputs.

The same can be applied for an Output and you could create a Mix that would be output to another device output (e.g. Hapi Headphones used by the drummer).

Peer for Remote Control PreAmps

Once an AD module from another device is peered from an Anubis, the PreAmps page of the Anubis is extended to that device's additional inputs, allowing remote control of a peered device AD module from within the Anubis TFT PreAmps page.

(Refer to the User Manual PreAmps section for all details on the PreAmps page.)

How to peer a device

Requirements:

- Have more than one Merging device such as a Horus, Hapi or Anubis
- The Horus and Hapi must be on firmware 3.10.0 and above.
- Anubis must be on Firmware 1.2.2. and above
- Make sure that those devices are connected to the same RAVENNA network as Anubis or have one of those connected directly to one of the Anubis SPS port (if you have that model)
- Warning: Peering Multiple Anubis is possible but might involve a different procedure. (Please refer to the "Multiple Anubis Peering" section)

1. Connect another Merging RAVENNA device your Anubis network
2. Under the Anubis Menu open the Peering page (available in Expert mode, refer to settings)

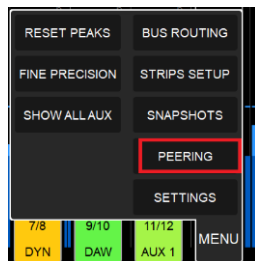

3. The online devices should be discovered on the left column

A screenshot of the 'Peering' page in the software. It shows a table with columns for 'Devices', 'Modules', 'Inputs', and 'Outputs'. The table lists three devices: 'Horus_80064' with three AES modules (AES 1, AES 2, AES 3) and 'Offline Hapi_90003' with three A/D modules (A/D 1, A/D 2, D/A 3). The input and output counts are shown for each module.

Devices	Modules	Inputs	Outputs
Horus_80064	AES 1	1-8	1-8
	AES 2	1-8	1-8
	AES 3	1-8	1-8
Offline Hapi_90003	A/D 1	1-8	n/a
	A/D 2	1-8	n/a
	D/A 3	n/a	1-8

4. Select the device you want to peer (Horus in the example here) make sure this one is online so on the same RAVENNA network as your Anubis.



5. Once selected, it will open the Device Modules and I/O's available for peering. Devices such as Horus have more I/O available that can be seen by scrolling down the page.

Devices	Modules	Inputs	Outputs
Horus_80064	AES 1	1-8	1-8
	AES 2	1-8	1-8
	AES 3	1-8	1-8
Offline Hapi_90003	A/D 1	1-8	n/a
	A/D 2	1-8	n/a
	D/A 3	n/a	1-8

Devices	Modules	Inputs	Outputs
Horus_80064	MADI 1	25-32	25-32
	MADI 1	33-40	33-40
Offline Hapi_90003	MADI 1	41-48	41-48
	MADI 1	49-56	49-56
	MADI 1	57-64	57-64
	Headphone	n/a	1-2



6. Select a module and the I/O's you wish to peer with Anubis. This will open a dialog from which, depending on the module I/O's available, you can choose between 1, 4 or 8 channels.

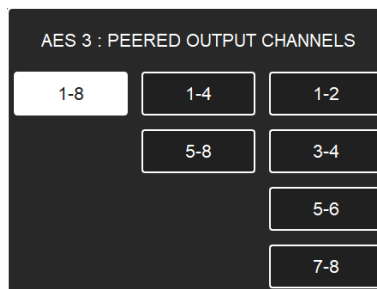

Note: For example we will peer the AES 3 modules output 1-8 and the A/D 1 input channels 1-8

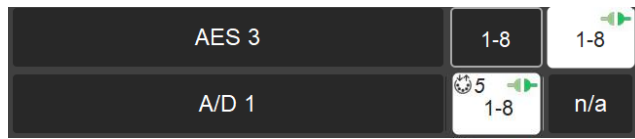

7. once peered the indicators should be green.

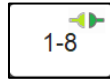

Note: A peered AD Module will indicate the PreAmps MIDI Pre Channel start number . IN the example below the Remote PreAmps will start as of preamps #5 for the A/D1 peered module



8. Exit the peering page from the Anubis Home button.



9. Notice that your Anubis Mixer now includes the peered channels, scroll the mixer UI to the right if needed to see them.

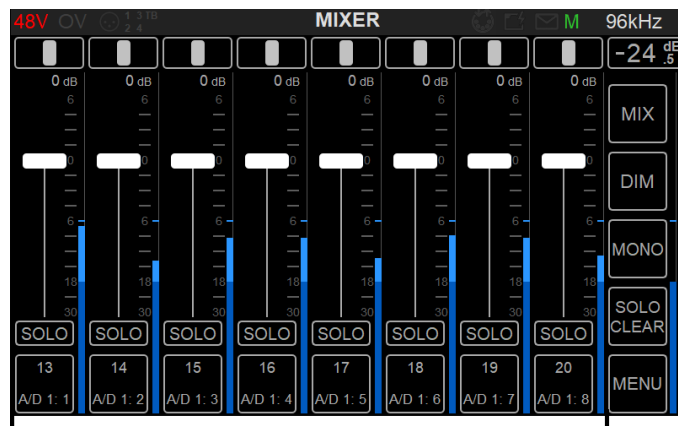

Peered Channels

10. The Peered AD modules will appear in the Anubis PreAmps page following the local Anubis PreAmps. Swipe from left to the right in the PreAmps page to access the peered PreAmps.

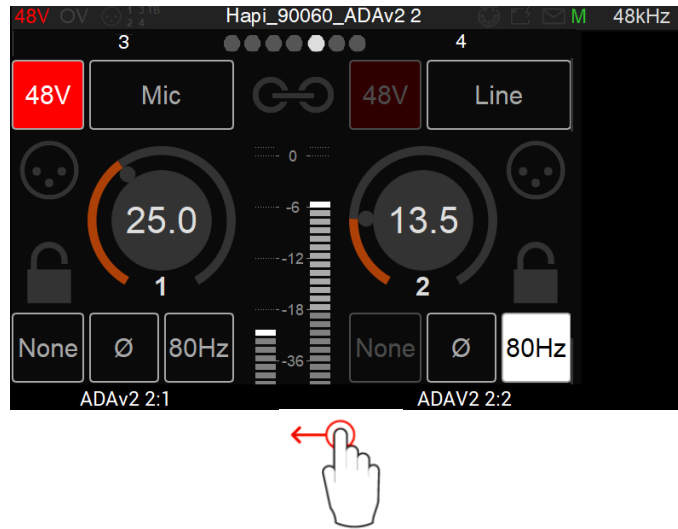

Note: Peered modules PreAmps from devices that are not an Anubis might not support some parameters (Cut, Lock, Boost)

10. Your output channels will be also available in the Bus Routing settings (reachable from Mix or Menu entries), where they are seen and available for routing in pairs.

Legacy (firmware 1.2.4 and prior)

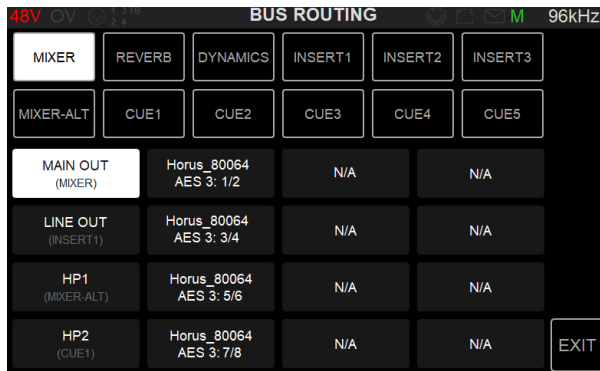

New Bus Routing (Firmware 1.2.5 and higher)

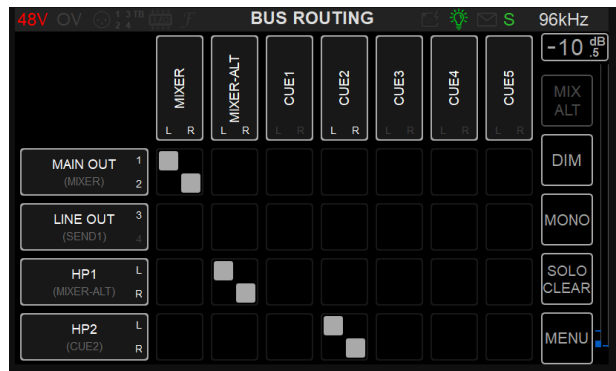

11. UNITE. From the MAD or VAD Panels performing a UNITE will create the Inputs streams connections for record back into a DAW.

Note: The Peered outputs are only available from the Anubis Bus Routing and not United. To connect those Back to your DAW it requires the users to make those connections from ANEMAN.

Your Anubis has now been extended to use those extra I/O's that are now available within the Anubis Mix engine and Bus Routing. Refer to the Bus Routing section for more details.

Offline peered modules can still be visible and adjusted in the mixer, but those will appear grayed out. Once the Peered module is back online the new parameters will be applied.



Offline Peered Inputs (grayed out)

Peering Rules

- Peering can only be performed from an Anubis and requires Merging RAVENNA devices
- 64 peered inputs officially supported (8 different modules of 1 to 8 channels each)
- 48 I/Os are available within one Anubis up to 4FS (192kHz), 24 I/Os in DXD 352.8 or 384kHz which includes the Anubis local inputs.
- An **output module** can only be peered by one device. If another device peer's the same output module it will disconnect the previous one. Last peering output module takes over
- A second Anubis can peer an **input module** that is already peered by another Anubis
- Peering is performed in Unicast, for Multicast support please use ANEMAN
- Offline devices' modules cannot be peered, then can only be un-peered.
- Peering does not require a system (PC/Mac) it can be performed with two standalone Merging RAVENNA/AES67 devices.
- Un-Peering and Re-Peering a module will reset the first applied Fader levels to nominal 0.

Multiple Anubis Peering

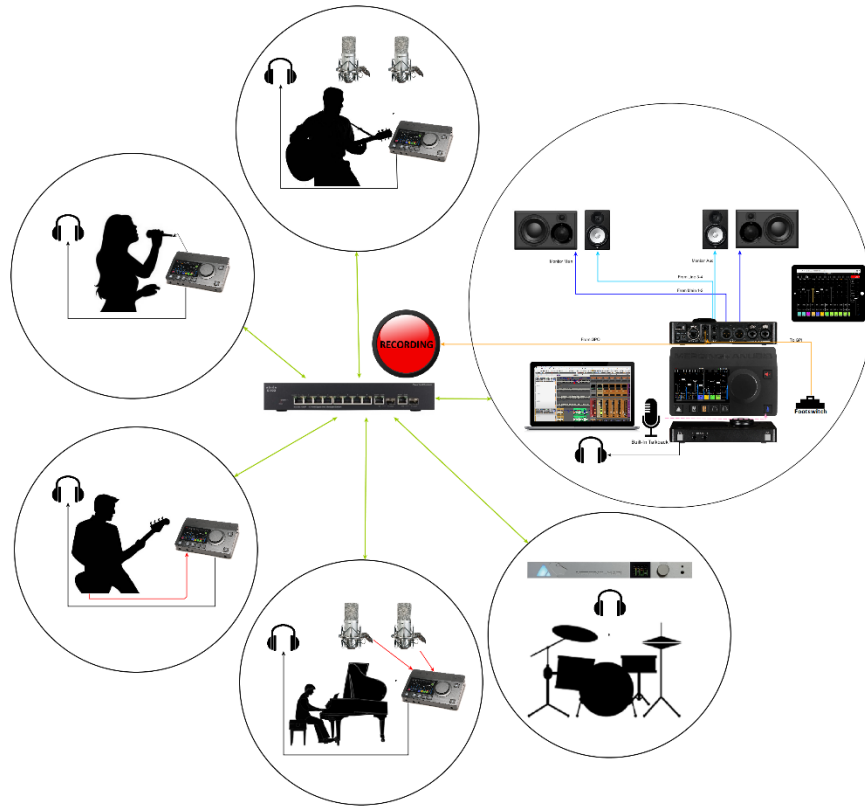

Having multiple Anubis over the same network may involve a different procedure as in some cases the performers will want to have control over their own cues along with exclusive effect processing within their Anubis.

In the scenario here, we are using multiple Anubis that are integrated in different recording booths for multiple performers. The idea behind this workflow is to send to your performers a foldback mix on which he will perform over by mixing his direct inputs with the foldback mix.

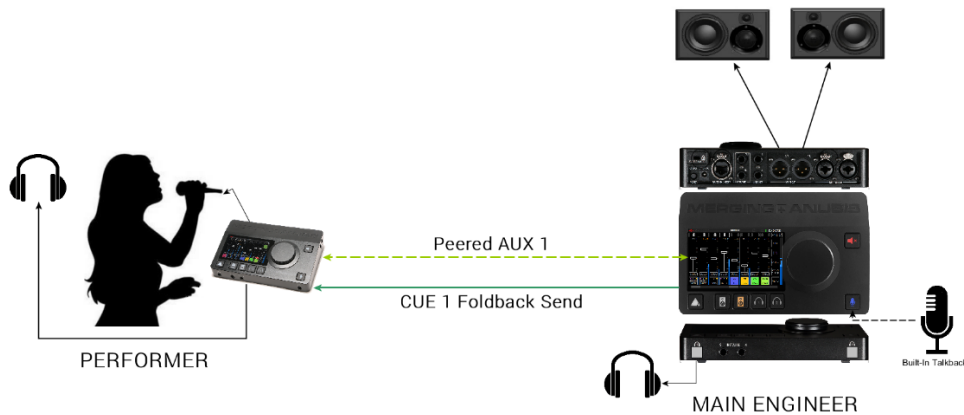

Procedure

1. All Anubis and/or other RAVENNA/AES67 devices should be connected to the same network.
2. The engineering control room Anubis will act as the main Anubis that handles all Cues and distributes the Auxes for each Anubis, while the Performer Anubis will be each of your artists.
3. If a DAW / AUX Software Playback is required, first establish those connections to the Main Anubis, so that it can monitor those inputs and eventually redistribute them in the foldback mix.
4. Open the Main Anubis Peering page and peer the performer's Anubis DAW or AUX depending on what you wish to send back to your performer.

Note: You could also peer its inputs but that would slightly increase the latency and prevent you from using the processing engine of the performer's Anubis (such as an independent Reverb setting).

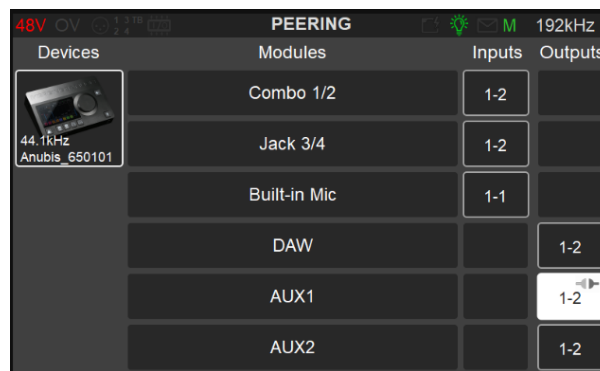

5. From the Main Anubis prepare the CUE Foldback mix of your performer without yet adding his own direct inputs to it. This foldback mix can be a downmix of all the current musicians playing live, or could be a metronome click track or a DAW software Playback (AUX outputs). Once this initial CUE mix is ready, from the Bus Routing Page connect the performer's Anubis AUX1: 1/2

Legacy (firmware 1.2.4 and prior)

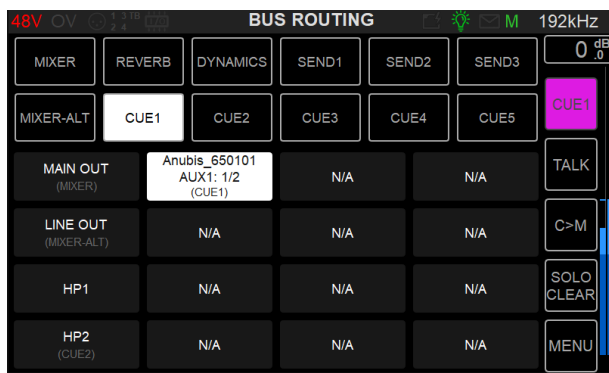

New Bus Routing (Firmware 1.2.5 and higher)

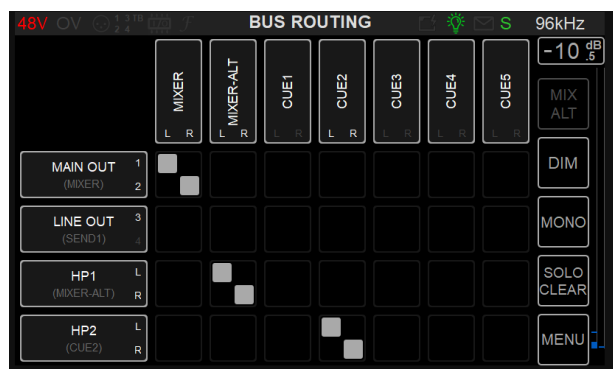

Note: It is recommended in such case to set the CUE volume level to nominal -20dB and never touch it.

6. The performer will then receive this foldback mix on his Aux 1 input and be able to mix his direct inputs channels along with it and apply his own effects such as EQ, Dynamics or Reverb.

Notes:

- The engineer can use the Web Access Pages in order remote control the performer's Anubis mix (his own Cue coming from the engineer's Anubis through an Aux input with his own local inputs)
- The engineer can additionally configure the performer's Anubis Strips layout from the SetUp page so that the performer sees only the faders he needs. Thus, his direct mics and the rest of the band mix, all this over just a couple of faders.
- Different workflows can be performed using the peering and the performer could also peer a large number of Inputs if more are needed.
e.g. A drummer could have his Anubis peering a Hapi AD8 in order to have all those inputs mixed in his Anubis, while the engineer still keeps control over those PreAmps for the recording part and monitor those via his DAW.

Talkback and Return Talkback

The engineer can at any time use the Anubis talkback built-in or any dedicated microphone input to interact with the performers (refer to the Talkback description in sections above).

If your performer requires a talkback mic, he can use the built-in Anubis one as well or any dedicated microphone input.

For such configuration the performer must inject his built-in talkback mic in a CUE that will be sent to the engineer's Peered Anubis Aux.

1. From the performer's Anubis peer one of the Sound Engineer Anubis AUX
2. From the performer's Anubis open the Bus Routing and select an available CUE to patch this to the engineer Anubis AUX
3. Go to the Sound Engineer Anubis, this one will now have monitoring of the performer's AUX within his Main Mixer as a return talkback.
4. On the engineer's Anubis make sure that under the CUE sent to the performer you Mute the AUX channel fader on which the Talkback return was sent to. Otherwise, the performer will also hear his talkback microphone.

ANUBIS BUILT-IN EFFECTS



The Anubis Music Mission includes three Anubis powered built-in effects. When applied in the Anubis mixer (Strip, Returns or Bus) those plugins run in realtime on the internal DSP engine.

MERGING+EQ

MERGING+DYNAMICS

MERGING+REVERB

Those built-in effects are the perfect solution for your performer's CUE. Apply effects to your performer's ultra-low latency mixes and give them the perfect listening environment: with Equalization, Compression and Reverb on their channel inputs in order to get the best performance out of your artist.

Those effect can be used in standalone, or can be routed back to a DAW for recording or for loopback processing applications.

Note: Users are free to use their own onboard effect processors and route those to one of the 3 available Sends.

MERGING+EQ

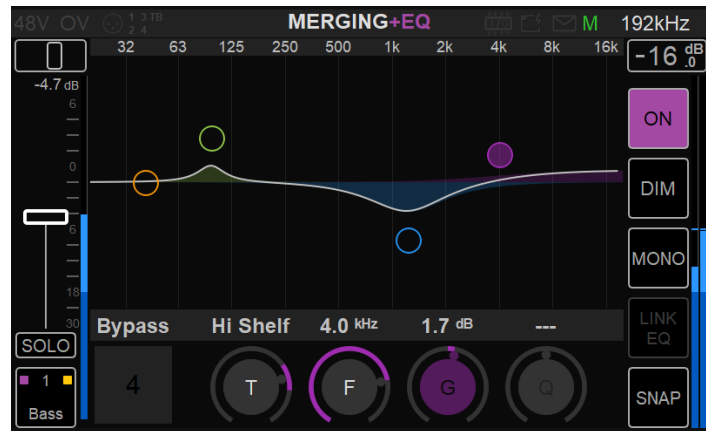

The Anubis EQ is built on the existing and universally acclaimed quality of the Pyramix EQ-X and offers extreme definition filtering at sampling frequencies up to DXD.

Our EQ support four bands of fully parametric EQ with independent control of filter type, gain boost and cut, frequency, and Q factor (bandwidth) for each band. With notch, low cut, hi cut, peak and shelving filter types available. The state space filter design of this extreme definition equalizer has been specifically optimized to deal with the highest audio resolutions while still permitting very low noise & distortion, typically offering a THD+N of better than -110dB, throughout the entire audible (and even non-audible) range. Of course, this new digital filter's topography, while designed with high sample rate in mind, also offers the extra benefits and low noise to 1FS equalization.

EQ can be applied to any inputs (Local or Peered) or to any Bus output (e.g. for headphones or room correction). The EQ resources are not cumulated but shared. This allows a complex equalization for each inputs or outputs, with a total of 21 x EQ of 4 bands each available in the Music Mission at any sampling rate.

ANUBIS EQ FEATURES

- EQ available for all Anubis users
- EQ Supported from 44.1kHz up to 352.8kHz (DXD) and 384kHz
- Up to 4 bands per channel. A total of 21 EQ instances are available at any sampling rate

ANUBIS EQ RESTRICTIONS

- No DSD support (in the Music Mission)
- No touch screen manipulation of the frequency movement or Q (not supported yet)
- Crossover uses 1 EQ (4 bands)

ANUBIS EQ PARAMETER CONTROLS

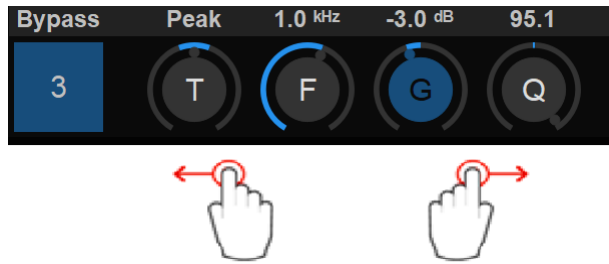

Operation: Select parameter to operate changes and use the Anubis Rotary to apply those.

EQ Band selection: Tap the frequency band on the UI itself that you want to configure, once a frequency band is selected, swipe to left or right on the Parameters control to access the adjacent band.

Bypass

2 Band Channel number: When a frequency band is selected, tapping this one under Bypass will Bypass that specific frequency only. (e.g. band 2)
Bypass Default Value: Disabled



Filter Type

Five Filter Types are available on all EQ bands.

Types:

- Low Cut (Lo Cut - high pass filter): 6 dB per octave
- Low shelving (Lo Shelf)
- Peak (Parametric)
- High shelving (Hi Shelf)
- High Cut (Hi Cut): 6 dB per octave low pass filter

Note: for 12dB per octave precision two bands are required.

Default Value: Peak



Band Frequency (up to 4)

Adjusts the center frequency for the band.

Unit: Hz and kHz

Value Range: 20Hz / 20kHz

Default Value for first five bands: 31Hz / 125Hz / 500Hz / 2kHz / 8kHz

Step: 24 steps per octave



Gain

This knob sets the gain in dB of the selected bands between -24 dB and +24 dB.

This setting is only used for Peak and Shelving filter types.

Default Value: 0 dB

Step: 0.1 dB



Band Q-Factor (7)

Adjusts the frequency range affected by Gain and Frequency on the band when the Parametric filter type is used. Q is only available for Peak Filter Type.

With a lower Q-Factor, a wider range of frequencies are affected, with a higher Q-Factor, a narrower range of frequencies are affected.

Value Range: 1 to 100

Default Value: 10

Step: 24 steps logarithmically distributed.

EQ Control Column

EQ side controls: Reference, DIM, Mono controls remains the same as the ones on the Mixer.

ON-OFF

Activate or no the EQ processing.

Link EQ

If you need to apply the same EQ parameters to a set of link channels you must enable Link EQ.

If you wish to apply different EQ to for example

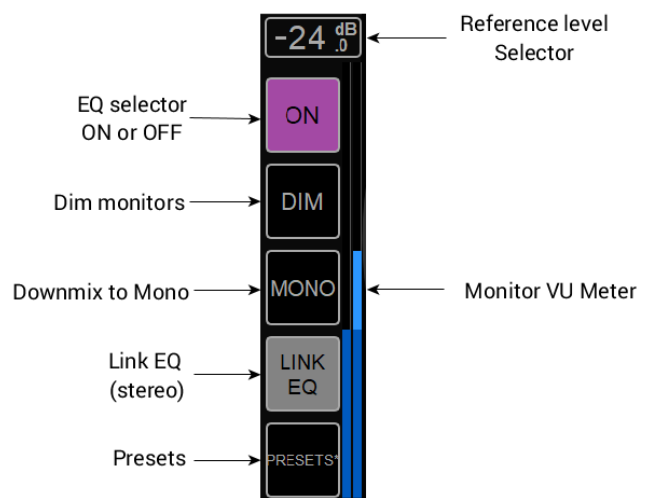

stereo linked channels, then enter the EQ with each channel and do not apply the Link EQ options.

Presets:

18 Presets for each of your Effects (EQ, Dynamics, Reverb). Recalling your favorite parameters is just at the tip of your finger.

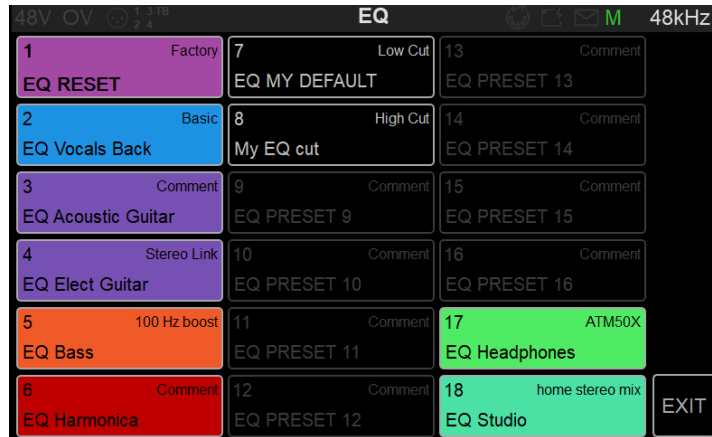

Tap and empty preset box to open the Preset Dialog.

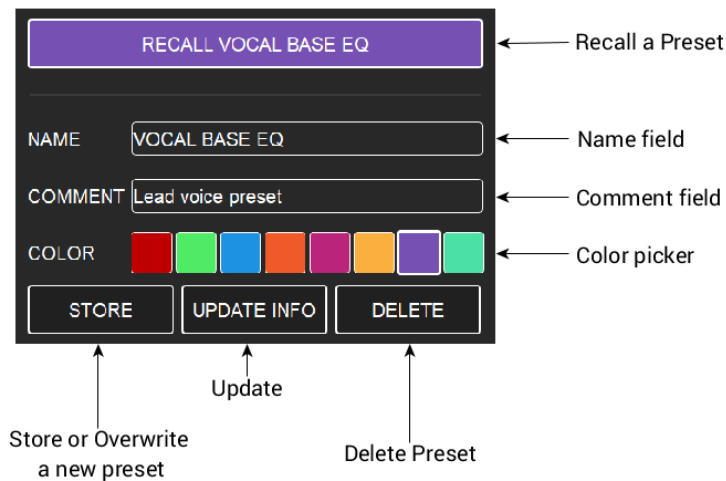

Press the Anubis home button to exit the Snapshot page and return to the Mixer view.

RESET EQ

Reset the EQ parameters by recalling the Dynamics Reset factory preset.



MERGING+DYNAMICS

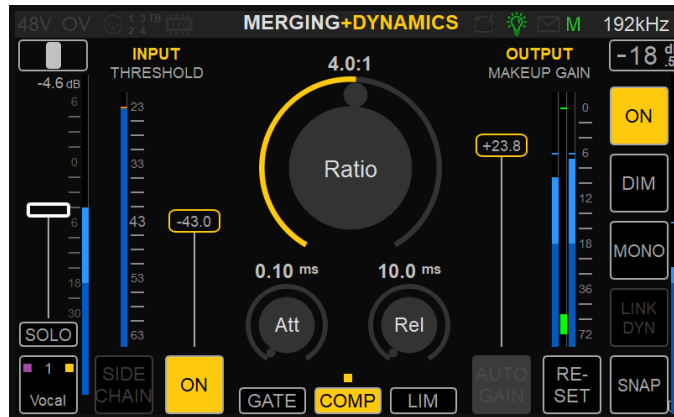

The Anubis Built-in Dynamics includes multi-modules. 1 X Gate, 1 X Compressor and 1 X Limiter that can be combined in series. With each module having its own parameter values. Limit your outputs buses or strip channel, apply compression to your strips, gate your snares or kick, compress and limit your vocals, compress your drums in parallel and more. The Dynamics can operate in Mono or Stereo mode (Link Dyn)

More than just a single Dynamics

- **A:** Available for any Strip Channel. Local or Remote/Peered inputs (e.g. vocals, guitars,...)
- **B:** Available as a Parallel Dynamics Bus Effect (e.g. To apply to an entire drum group)
- **C:** Available on any Output Bus. Local or Remote/Peered (e.g., To limit outputs, headphones)

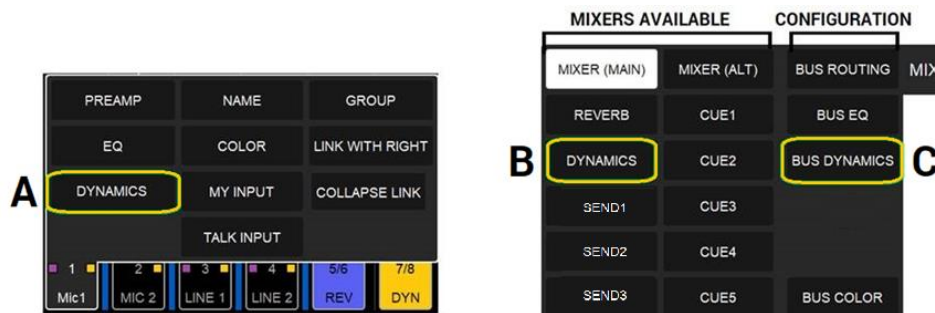

ANUBIS MERGING+DYNAMICS FEATURES

- MERGING+DYNAMICS is available for all Anubis users
- MERGING+DYNAMICS Supported from 44.1kHz up to 352.8kHz (DXD) and 384kHz
- MERGING+DYNAMICS supported instances
 - 64 x DYNAMICS instances at 1FS (44.1/48kHz)
 - 32 x DYNAMICS instances at 2FS (88.2/96kHz)
 - 16 x DYNAMICS instances at 4FS (172.4/192kHz)
 - 8 x DYNAMICS instances at 8FS (DXD-352.8/384kHz)

Dynamics Modules

The MERGING+DYNAMICS includes 1 X Gate, 1 X Compressor and 1 X Limiter



Gate

The Gate attenuates the signal with levels below the threshold

Compressor

Pure transparent and discrete compression with the option to produce classic fat compression making it perfect for both creative mixing and production as well as for discrete mastering and post-production.

Limiter

Limits the level of a signal to a certain threshold

DYNAMICS PARAMETERS

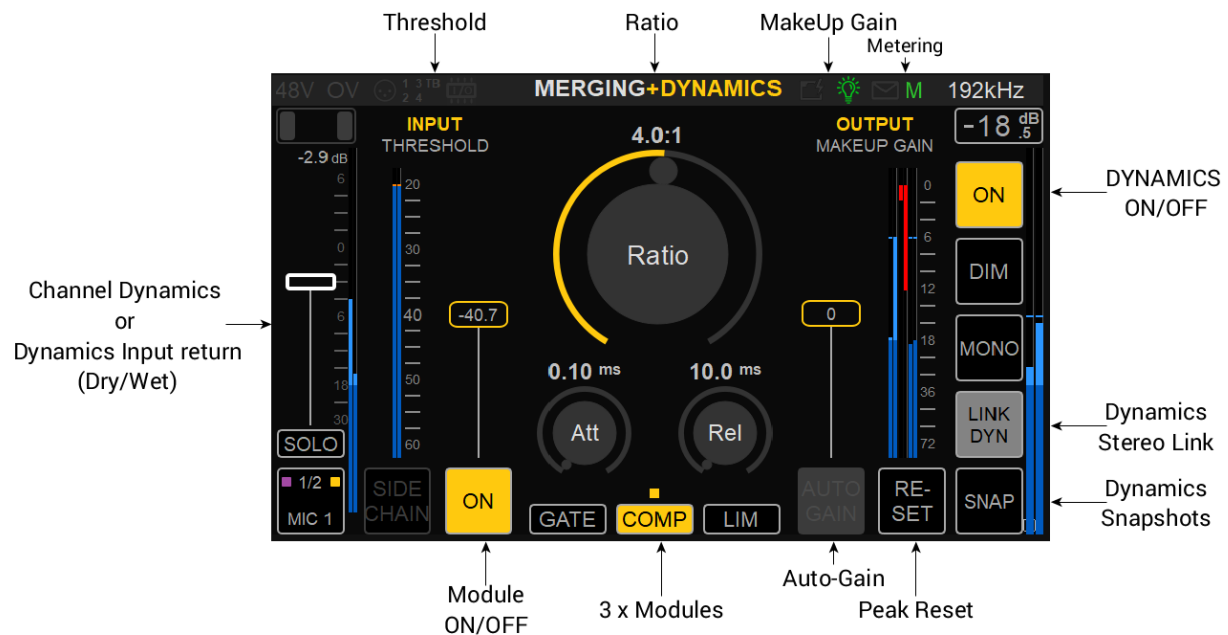

Dynamics ON/OFF

Activation button, when set to ON the Dynamics is active, when disabled the Dynamics is not active, nor routed.

Threshold

Threshold control sets the level above or below which the plug-in will affect the dynamics of the input signal. Each module has its own Threshold value and range.

The Threshold fader has an auto-scroll scale for precise operation. When lowering the Threshold value, the metering scale will be adapted in a 40dB scale range view.

Gate Threshold range: -144dB to 0dB

Compressor Threshold range: -96dB to 0dB

Limiter Threshold range: -96dB to 0dB

Ratio

Compression ratio determines how much gain reduction the compressor applies when the signal passes the threshold level.

For a 1:1 compression ratio, the processed signal isn't affected by the processing: A 1 dB variation above the threshold at the input is reflected by a 1 dB variation at the output. Try applying a 4:1 ratio, if the input signal rises above 4 dB the threshold value, the output signal rises only by 1 dB: Here is the compressor action. The input signal gain is reduced by a 4:1 ratio above the threshold point. Limit and Gate have fixed ratios.

Compressor Ratio Range: 1.0:1 to 32.0:1

Output / MakeUp Gain

The makeup gain parameter refers to a gain control at the output of a compressor. Compressors reduce the level of the loudest signals, so after implementing compression, you usually end up with a quieter signal than the original.

Range: +36dB to -36dB

Metering

Input level, gain reduction and output level meters. Their read-outs provide an immediate overview of the current levels.

Gain Reduction Meters: This shows the instantaneous gain reduction in dB (red below 0 dB) or gain increase in dB of the Dynamics processing

Output Meters: Full-scale meters with peak hold values for each channel.

Attack

Attack time sets the response speed of the processor when a threshold level is reached.

For transient-rich program material like drums, fast attack times are needed to minimize overshoot. For other program material, too short attack times may dull the sound or introduce audible distortion.

Range: 0.1ms to 200ms

Release

Release Time sets the rate at which applied gain change returns to unity after the threshold is no longer exceeded. In most cases, the release time is very program dependent.

Range: 10ms to 2 sec

Sidechain

Under Development

ON/OFF

Module activation. The Gate, Compressor or Limiter modules have their own activation setting

Module Selector

Select which module you wish to operate by tapping and activating this one

In the image here the compressor module has been selected. Thus, all parameters reflect the selected module.



Module Status

Module LED indicator, indicates if a module is active.

In the example here the Gate and Limiter modules are enabled but not the compressor



Auto Gain

Under Development

Reset Gain

Long press the output fader will reset it to 0dB

Peak Reset

Reset all the peaks of your Dynamics meters by tapping the Reset button.

Link Dyn

Enable if you wish to apply the same Dynamics parameters to a set of link channels such as a stereo strip (linked).

RESET

Reset the Dynamics parameters by recalling the Dynamics Reset factory preset.



MERGING+REVERB

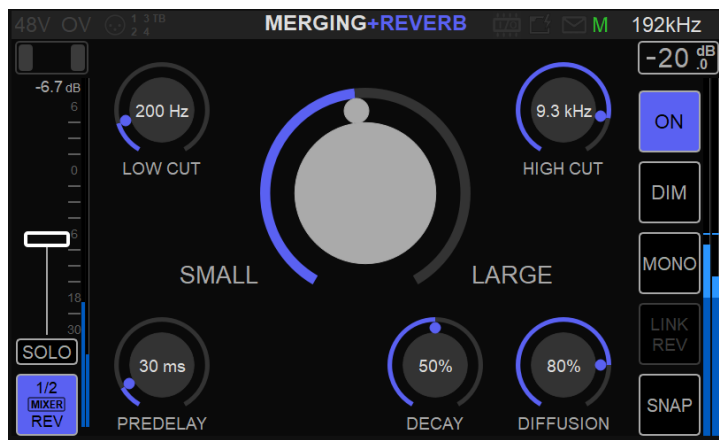

The MERGING+REVERB is included in every Anubis Music Mission (free of charge). One Reverb is available and can be applied to multiple channels using the Sends control. The Reverb is a stereo Reverb.

How to operate

From the Mixer Reverb Input Strip enter the Reverb Bus from the Quick Access menu, selecting the GO TO REV Bus entry.

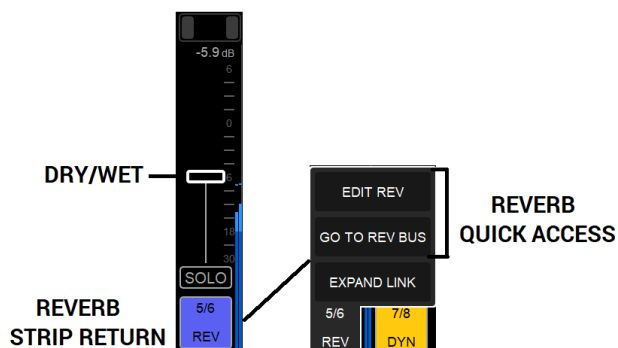

Note: You will need increase the Reverb return input level in order for the Reverb signal to enter back into your mixer. The fader will then act as a Dry/Wet global parameter.

The Reverb can also be accessed from the Mixers menu

MIXER	MIXER-ALT	BUS ROUTING	REV
REVERB	CUE1		EDIT
DYNAMICS	CUE2		SNAP
SEND1	CUE3		SOLO CLEAR
SEND2	CUE4		
SEND3	CUE5	RESET	MENU

From the Reverb Bus, the faders will act as the Reverbs sends. In the example below we are sending Reverb to the vocals and to the guitar, but not to the bass nor line 4 inputs.



Tap the EDIT button to open the REVERB UI in order to adjust the Reverb parameters

REVERB PARAMETERS



REVERB RETURN INPUT:

The Reverb return input channel is the same as the one found in the Main Mixer page. Increase its level in order for the Reverb signal to return to your mixer. The fader will then act as a Dry/Wet global parameter.

REVERB SIZE (Small to Large)

Adjusts the size and shape of the virtual room and will change the pattern and spacing of the reflections from a small room to a large room, hall or cathedral.

You can dial in short, bright reverb for a small room, up-front vibe, or long to dark reverb that places your mix in deep space.

The Reverb size parameter can be used in tandem with the other parameters to alter the room sound.

LOW CUT

Use this parameter to reduce low frequencies entering the reverb. This can prevent a muddy, indistinct sound that takes focus away from low frequency signal such as the drum kick and bass.

Low Cut Range: 10Hz – 20kHz

HIGH CUT (High Frequency Damping)

Reduces the high frequencies going into the reverb. If your reverb sounds metallic, reduce the highs starting at 4–8kHz.

High Cut Range: 10Hz - 20kHz

PRE-DELAY

When listening to a performance the direct sound is the first reaching us, followed by the reverberation coming from the room reflections.

The pre-delay is the amount of time between when the direct sound arrives and when the reflections arrive.

Pre-Delay Range: 0- 300ms

DECAY

Represents the decay time of the Reverb. Which is the amount of time it takes for the sound pressure level (SPL) in a room to fall.

A reverb setting with strong early reflections and a quick decay is a great way to create a stereo effect from a mono source. Bigger rooms will have longer reverb tails, smaller rooms will have shorter reverb tails.

Decay Range: 0 -100%

DIFFUSION

Controls the rate at which the reverb tail reflections will be built in density. The higher the diffusion the more regular the density of reflections will be in terms of timing, levels and pan position. Generally, higher settings can make for a more natural-sounding reverb and lower settings for a more 'airy' effect.

Diffusion Range: 0 -100%

DRY/WET

Dry and Wet level must be adjusted from the Reverb Bus send fader for individual strip and the overall Dry-Wet level must be adjusted from Mixer Reverb Input Strip Return.

The dry/wet control allows you to alter the balance between the untreated (dry) track and the track after reverb is applied.

Note: Each mixer can have its own Reverb Strip return level. So that the Singers CUE 1 could have a greater Reverb return level on her vocals than the CUE 2 (guitar player)

18 Reverb Snapshots:

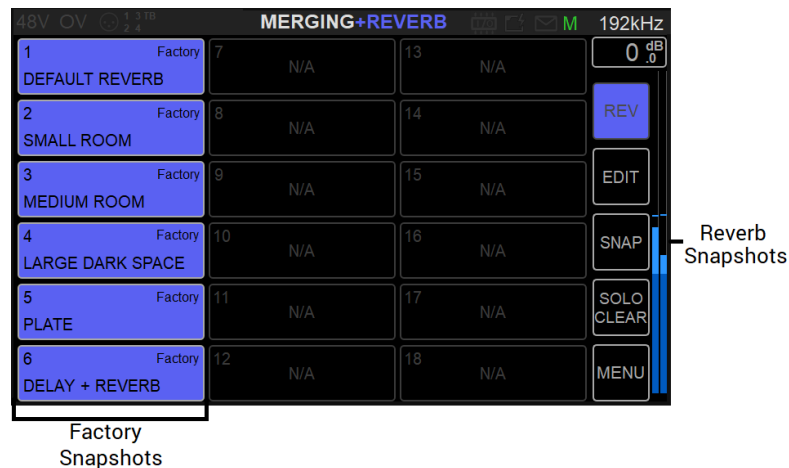

Six factory preset reverbs are available to start with and users can store their own presets in the 12 remaining Reverb preset entries.

6 x Reverb **Factory Snapshots**

Those snapshots are read only and cannot be overwritten, but can be customized and resaved.

DEFAULT REVERB: Generic reverb ambiance of a rather large space and flat space.

SMALL ROOM: Small size studio room with short reflection

MEDIUM ROOM: Mid-size studio room reverb.

LARGE DARK SPACE: Larger reverb space with reduced high frequency.

PLATE: To add brightness to an instrument, useful on vocals or drums snare or overheads

DELAY+REVERB: Using low diffusion parameter value will increase the reflexional effect and act as a delay. The Small – Large parameter can then be used to change the delay time from short to long delays.

PREAMPS CONTROL

Enter the Anubis PreAmps from any of the Anubis Mixer Strip Channel. Selecting the Preamps entry from the Strip channel options menu will open this PreAmps input channel page

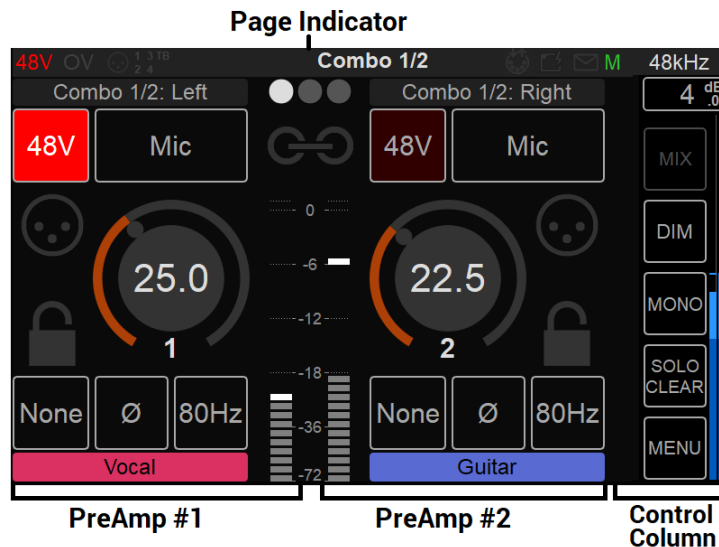
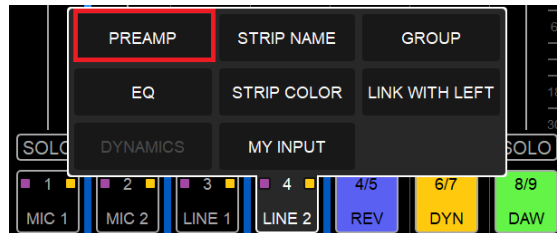

PreAmps Page indicators

The Preamps Information bar on top of the controls displays: The Input Channel identification, the page position and the name of the Output Monitor set selected.

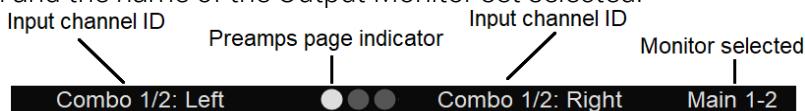

PreAmps Names

Example: Combo 1/2: Control over the physical XLR/TRS Combo (6.3 mm / 1/4" connection) Mic/Line inputs located on the back panel of the ANUBIS

The PreAmps name can be edited by tapping on the Input Channel ID name

At the bottom of the PreAmps, the names refer to the Music Mission Mixer strip channel names. Those can be renamed from the Mixer page and will preserve their Mixer strip color.



INPUTS OPTIONS:

48V

48V: When enabled, it will turn on the 48V phantom power for channel 1 or 2 of the Anubis meaning that the Phantom power becomes active, typically needed for condenser microphones.

Note: Only active on channels set to Mic (Anubis XLR/Combo Inputs 1-2).



Warning:

The 48V power MUST be turned off prior to changing the connection in certain patch bays. Many such patch bays do short the Hot, Cold or both signals to Ground during insertion or removal of the Jacks with the risk of deteriorating permanently the protective resistors in the input of the Preamp circuitry. If an AD module input circuitry is damaged, following such a short, it will end up permanently having inaccurate gain levels, distortion or even no signal at all on some channels. Such damage is not covered by our warranty.

Mic

Mic/Line: Switches the Input between the Mic-Pre amplifier and the Line level circuitry. The option will show the current input signal path it is set for Mic or Line.

Line

The Line input sensitivity, switch from Mic to Line level and impedance
Line Fader of 0 dB, means 0 dBFS for +24 dBu Analog signal level present at the Line input
Line Fader of + 6 dB, means 0 dBFS for +18 dBu Analog signal level present at the Line input
Line Fader of + 20 dB, means 0 dBFS for +4 dBu Analog signal level present at the Line input
Line Fader of + 66 dB, means 0 dBFS for -42 dBu Analog signal level present at the Line input

Note #1: the Mic, Line and Instruments inputs are stored as independent parameters, meaning that switching from mic to line to instruments and vice versa will load their stored gain (sensitivity) value

Note #2: The ANUBIS Premium has been designed in order to be able to benefit from the +3.1 dB SA-CD headroom offered by DSD, as per the Scarlet Book standard. Therefore, a minimum of +6 dB gain is required on the mic preamp or line input. This gain is applied in the digital section post AD just prior to the sigma delta 1-bit modulator. It is automatically applied as soon as the ADs are switched to DSD (64, 128, 256FS) and is visible in the preamp page. The gain can be adjusted between +0dB and +66dB in DSD mode. In Line mode, with a gain of +6dB, an input of +21dBu will generate a signal of +3dB SA-CD, in Mic mode, with the same gain, an input of +9dBu would generate a signal of +3dB SA-CD.



Gain: Tap the channel you wish to adjust. When the Gain is highlighted the Anubis Rotary Control lets you adjust the value in 0.5 dB steps. The Gain range goes from 0 dB to +66.0 dB. Turn the Rotary knob clockwise to increase the Gain value and turn counter-clockwise to decrease the Gain value.



Link: Tap to link a pair of input Preamps and control their settings simultaneously. Changes will then be applied to both channels while keeping any gain value offset (if present).

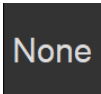

None: Max Mic input level +12dBu for 0dbFS (when gain set to 0)



Pad: Attenuates (lowers) the mic input signal level by 12 dB > max mic input level +24dBu

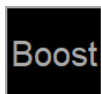

Boost: Increases (boosts) the mic input signal level by 12 dB > max input level 0dBu *Note: Useful for Ribbon Microphones that have low output.*

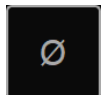

Polarity: Polarity invert option. When lit, it inverts the polarity of the selected input signal.



80 Hz: Low cut filter 80 Hz. Second order, 12 dB/octave.



Cut: This option allows the operator to Cut a channel input. By example to Cough Cut a microphone input. It can also be used to avoid potential noise when connecting or disconnecting an XLR or Jack input.



Lock: Enabling the lock option will prevent the input parameters being changed. This could be useful for safety or in order to maintain the calibration for an external analog processing chain.

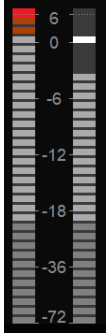

Meters: The Meters default display scaling range goes from -90 dBFS to 0 dBFS.

Note: Refer to the General Settings in order to configure and adjust the level meter color range (Peak, Alignment and Decay time). Refer to the DSD section for Meters.

Peaks: The top red led of the Preamp metering will indicate that a Peak has occurred. In order to clear the Peak display, simply tap on the meters VU to clear the Peak.

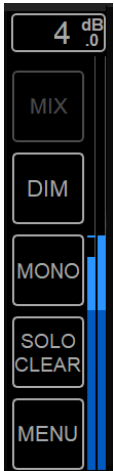

Control Column:

Similar to the main column with some differences in the menus.

Mixers menu is not active but will display the selected monitors set.

The Output meters on the far right display the output level and metering of the selected mixer bus whether it is a local (Main, Line, Headphones 1, Headphones 2) or from a peered monitor set. The name of the selected output is displayed at the top of the meters.

Dim, Mono and SOLO Clear are functional as per other pages.

The Lower Menu provides a shorten list of options.

Inputs 3-4 Instruments/Line:

Swipe from Right to Left on the TFT screen to access the Anubis Inputs 3-4

The location indicator will show second Preamps page.



The Instruments (Hi-Z)/Line inputs 3-4 are the ones located on the front panel of the ANUBIS on 1/4" connectors (6.3 mm). This second Preamps page will give you control over those Preamps.

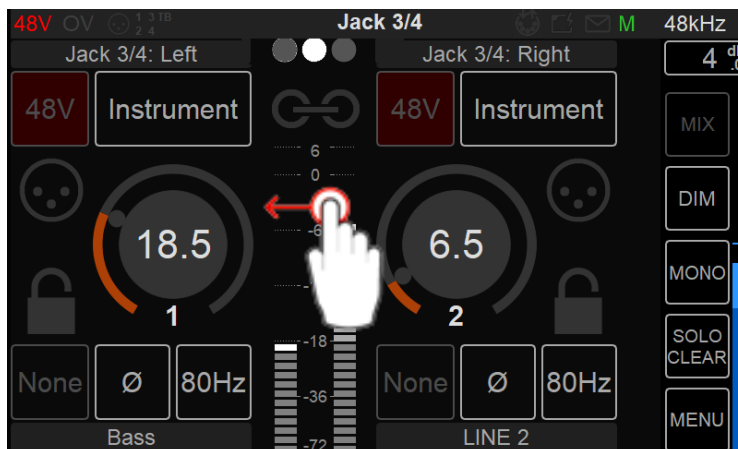

The Preamps controls for those inputs 3-4 are similar to inputs 1-2 but will apply to Hi-Z, Instruments or Line inputs types only. Thus, the 48V Phantom power and Pad/Boost options are not available for the Anubis inputs 3-4.

Note: Input 4 is shared with the Built-in Talkback. Connecting an Instrument or Line input jack into this input will deactivate the built-in Talkback (Channel 5).

It is recommended when you pull out a jack from input 4, to either Mute your Monitors or Cut the Input 4 preamp signal prior to pulling out the jack to avoid an accidental short feedback situation between the built-in talkback mic and the monitor set.

Input 5 Built-in Talkback:

Swipe from Right to Left on the TFT screen again to view the Anubis Input 5 that is dedicated to the built-in Talkback microphone

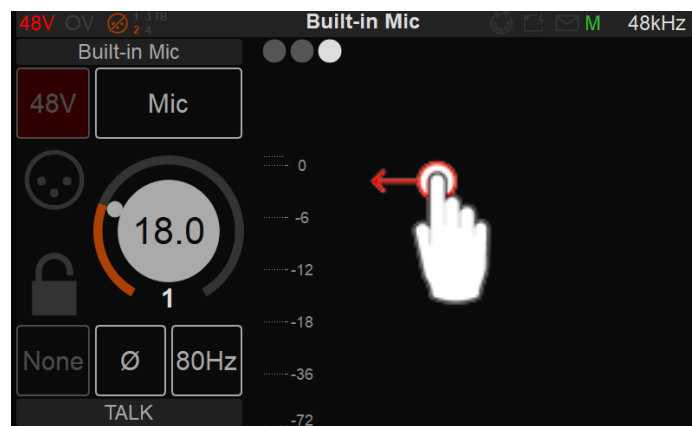

The Preamps controls for the Input 5 will control the built-in Talkback microphone.

Notes: The Input 5 Built-in Talkback is shared with Input 4. Connecting an Instrument or Line input jack into this input will deactivate the built-in Talkback (Channel 5).



Swipe on the TFT screen from left to right in order to return to the previous Inputs Preamps pages.

Note: More than three Preamps pages will be available if Split Channel is enabled under Settings>Inputs>Split.

Remote control of the Anubis Mic Preamps using ProTools DAW.

Mac: User should refer to the VAD User Guide for details on the procedure to follow [Virtual Audio Device guide](#)

PC: Users must refer to the RAVENNA ASIO Guide or Merging Audio Device (MAD, for details on the procedure to follow

[RAVENNA ASIO guide](#) or [Merging Audio Device \(MAD\) guide](#)

Remote MIDI preamps limitations (Boost, Link, Cut):

Boost: Remote MIDI Preamps control does not support the Anubis Boost Preamps option. It will be interpreted as a Pad. For the moment it is recommended to set this parameter locally on the Anubis Preamps.

Link and Cut: Remote MIDI-Preamps control does not support the Anubis Link Preamps option. Users can use Stereo Inputs. The Cut option will also need to be used locally on Anubis.

PEERED PREAMPS

Once you have Peered a Merging RAVENNA/AES67 device in Anubis those, PreAmps AD modules will appear in the Anubis PreAmps page following the local Anubis PreAmps and allow the operator to control the PreAmps of this device directly from the Anubis itself

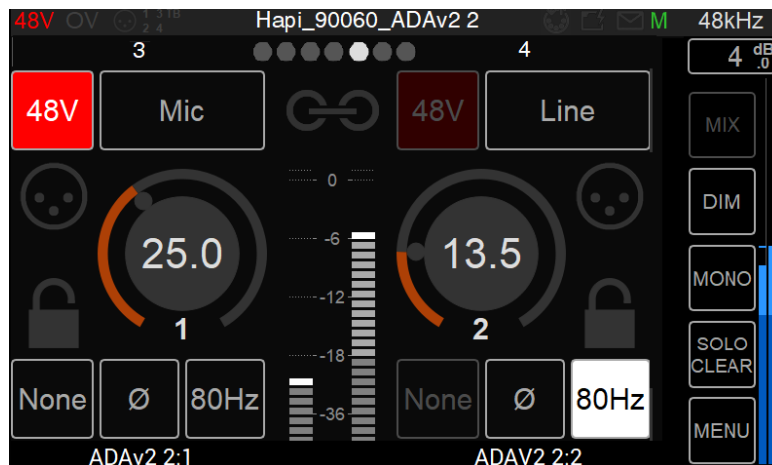

Swipe from left to the right in the PreAmps page to access the peered PreAmps.

Note: Peered modules PreAmps might not support some parameters (Cut, Lock, Boost)



Press the Anubis home button to exit the Snapshot page and return to the Mixer view.

Peered PreAmps Remote Web Access

Remote control your Anubis peered PreAmps from Web Access.

Procedure Open the Web Access page from ANEMAN, MT Discovery or one of our Drivers panels (MAD or VAD) by clicking on the Anubis Icon.



This will open the Anubis Web Access and bring you full remote control over the Anubis Music Mission. Google Chrome is the recommended remote browser.

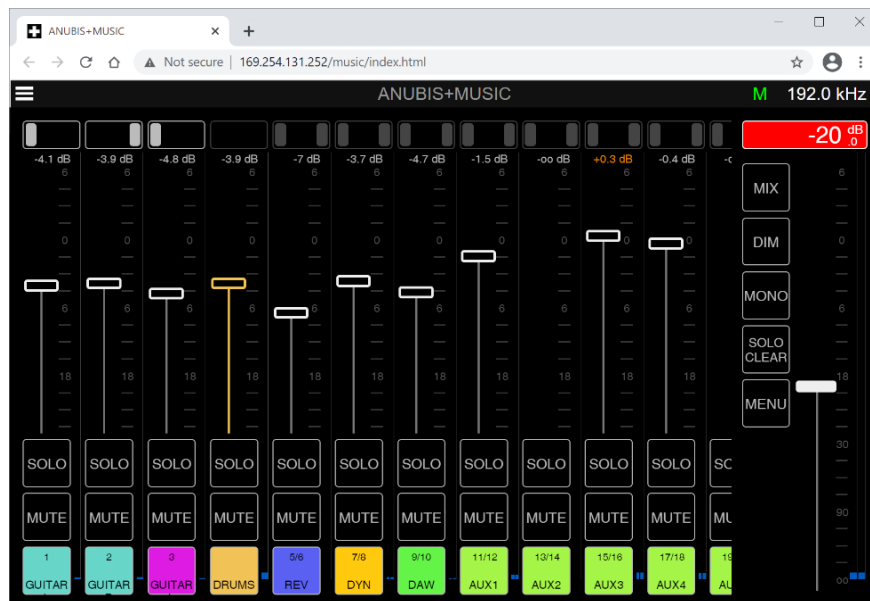

Open the Remote PreAmps page by selecting this one from the Mission Browser menu

 Click on at the top left corner to display the Menu options

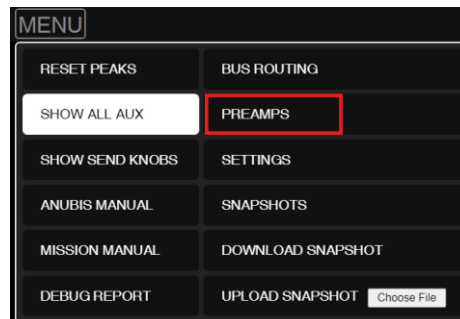

Example of PreAmps with peered modules remote control

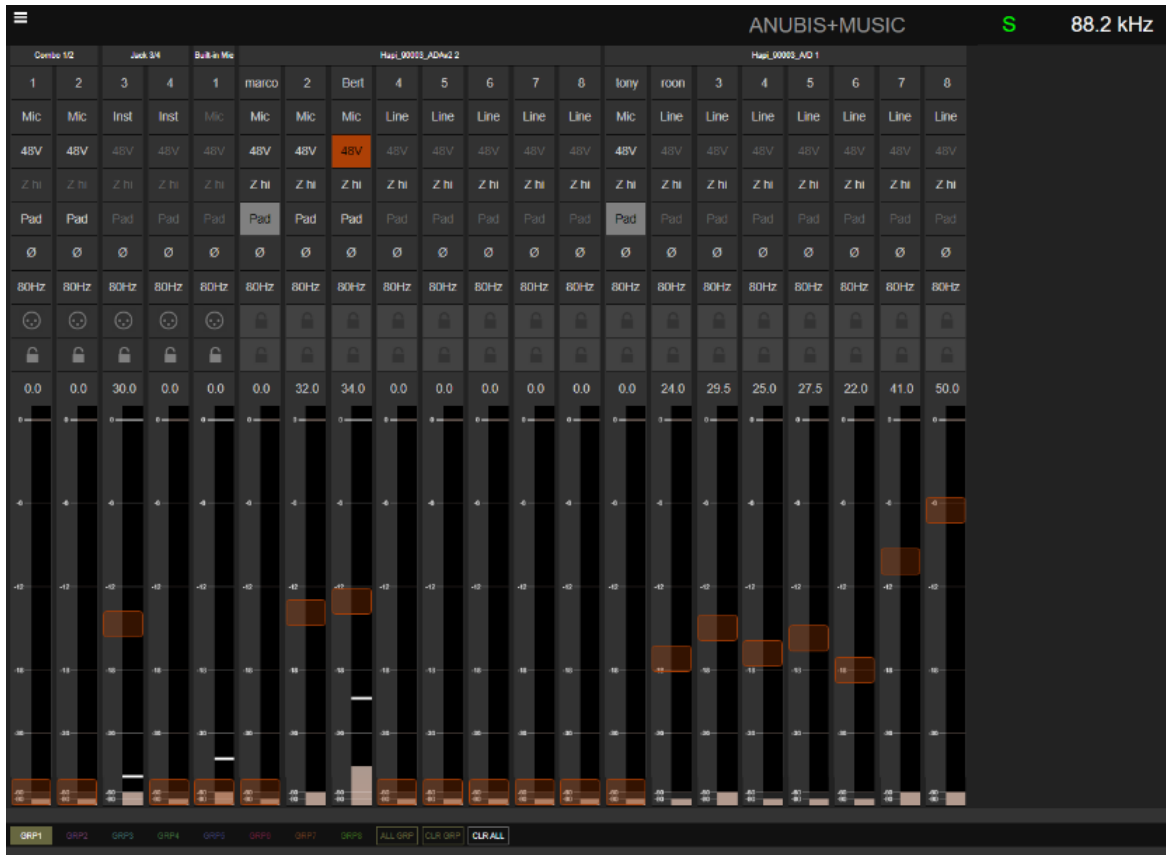

SETTINGS and WEB Access

The Anubis Music Mission Settings can be accessed from the Menu options (bottom right of UI)

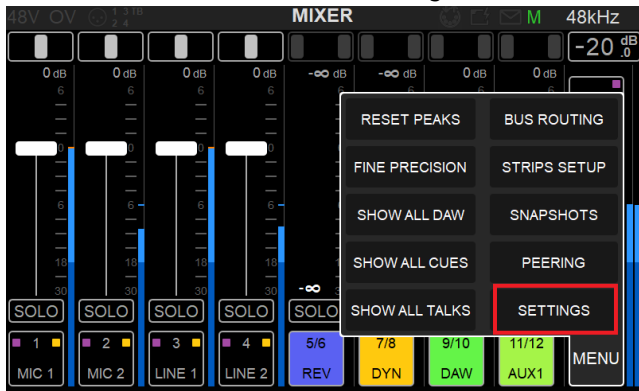

User can also access the Setting by doing a long press on the Anubis Home button.



On the Home page press the Settings Icon to enter the Mission Settings.

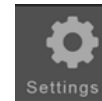

This will open the Settings page

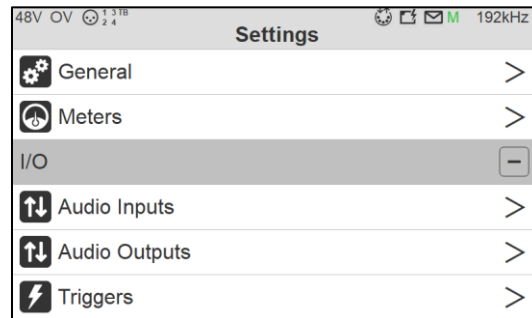

scroll up or down to view and navigate through the settings entries

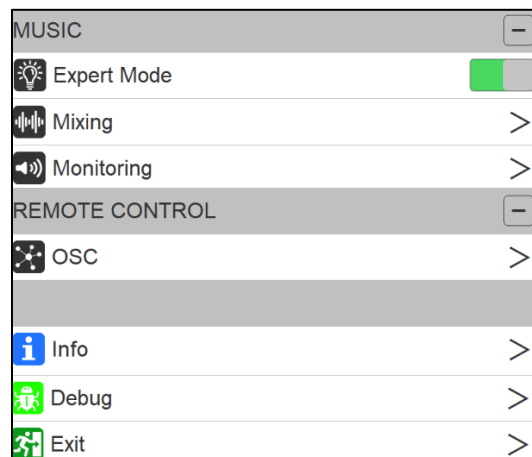

SETTINGS CATEGORIES DESCRIPTION



GENERAL SETTINGS

Sample Rate



Sampling Rate

Selector to the different sampling rates, available from a dropdown menu.

Anubis Pro: 44.1kHz, 48kHz, 88.2kHz, 96kHz, 176.4kHz, 192kHz

Anubis Premium: 44.1kHz, 48kHz, 88.2kHz, 96kHz, 176.4kHz, 192kHz, 352.8kHz (DXD), 384kHz, DSD64, DSD128, DSD256.

Warning: DSD is not supported by the Music Mission Mixer without alternative monitoring support. But it remains possible to record direct to a DAW in DSD while running the Music Mission, but monitoring will not be possible from Anubis.



A/D Mode in DXD/DSD:

This format setup only applies to the AD (PreAmps) which can be set to either DXD - DSD64 - DSD128 - DSD256

	DXD
 A/D Mode in DXD/DSD	DSD64
	DSD128
	DSD256

The Anubis can be configured in DXD/DSD, in this mode the Anubis can receive any audio data format stream and can generate DXD or DSD64, DSD128 or DSD256 stream depending on the A/D or Stream audio data format chosen.

It is recommended to set the A/D mode to the same sampling rate as selected for your project. However, DAW's such as Pyramix can record in a DXD project with the A/D mode set to DSD formats, this feature is only available for MassCore users (not supported in Native/ASIO) and can be quite resource demanding for high channel counts.

Warning: The Music Mission Mixer does not support DSD but supports DXD/352.8kHz and 384kHz.



Auto

Auto Sampling Rate mode, when enabled, will make Anubis automatically follow the sampling rate given by a RAVENNA/AES67 source provided by either; ASIO, Virtual Audio Device (VAD), MassCore or another interface with PTP clock. Enabled by default.

Example 1: User using an external player (such as a DAW) can enable the Auto mode so that Anubis automatically changes its sampling rate according to the project settings.

Example 2: This Auto setting is also useful in a network configuration following the RAVENNA ASIO/Virtual Audio Device (VAD) settings, where Anubis will adapt its sampling rate automatically.

Note: Both examples above are valid provided at least one RAVENNA ASIO or Virtual Audio Device (formerly Core Audio Driver) stream is connected to an Anubis Source.

Note: If using ANEMAN with a Sampling rate zone the device on the Crown this one will decide of the Master sampling rate. In such a case it is recommended to disable the Anubis Auto Sampling Rate mode to avoid fights follow the sampling rate of the non-Crowned devices at a given moment, that could potentially sampling rate flickering.

Frame Mode



Latency

Modes available in samples: AES67 (6), AES67 (12), Ultra (16), Extra (32), AES67 (48)* & Low (64). The selected mode will determine the device latency over a RAVENNA network. When multiple RAVENNA devices (e.g. Anubis) are connected over a network, they should be configured in order to adjust themselves to the lowest latency that can be globally achieved.

** Ex-factory default mode*

Clock

About the PTP Clock: The Precision Time Protocol (PTP) is a protocol used to synchronize clocks throughout a computer network. Also known as IEEE 1588 or IEC 61588, it is a protocol designed to synchronize real-time clocks in the nodes of a distributed system. RAVENNA is based on and uses V2 of this IEEE standardized protocol. PTP Clocks allow for time resolution to the Nanosecond.



PTP Master

If multiple AoIP devices are used in a network environment, Anubis will try to be elected as the PTP Master priority when enabling this setting, using the Best Master Clock Algorithm (BMCA):

Note: Non-Merging devices might not consider Anubis as the PTP Master



PTP Status

Information on the Anubis PTP status. Save or Master indicator and Unlock, Locking and Lock status.



ASIO Clock

Auto: The ASIO clock will be generated by the Anubis which will be PTP Master

On: The ASIO clock will always be generated by this Anubis regardless of the Master

Off: The ASIO clock is never generated

Note: Set to Off only if you are sure that no Anubis will be PTP Master, or if you are configured for a Unicast (point to point) workflow.

Interface Controls



Brightness Display

Adjust brightness of the TFT display using the Anubis rotary encoder to increase or decrease it.



Buttons Intensity

Adjust brightness of the Anubis physical buttons by using the Anubis rotary knob to increase or decrease the intensity.

Fan



Fan

Cooling Mode: Settings are available for either Low, Mid or High Cooling. This affects the threshold at which the fan will start to operate, with reference to the temperature measured

internally. While there is no universal preferred setting, we recommend that unless noise levels are a concern, you leave the setting on Mid for adequate cool operation and protection.

- **Low:** Fan starts above 50°C

- **Mid:** Fan starts above 45°C

- **High:** Fan starts above 40°C

When above these thresholds, Fan always starts at the lowest speed (minimum noise), and gradually increases proportionally to the measured temperature.

Note: The Anubis will shut down automatically as a precaution when reaching a temperature of 66°C.



Stop on Talk

Enabling the Stop on Talk option will stop the Fan when engaging the Anubis Talkback button. Once released, the fan will start back if it has to (depending of the measured temperature).

Network Settings

Obtain an IP address	<input type="button" value="Auto"/>			
IP address	<input type="button" value="192"/>	<input type="button" value="168"/>	<input type="button" value="1"/>	<input type="button" value="122"/>
Subnet mask	<input type="button" value="255"/>	<input type="button" value="255"/>	<input type="button" value="255"/>	<input type="button" value="0"/>
Default gateway	<input type="button" value="0"/>	<input type="button" value="0"/>	<input type="button" value="0"/>	<input type="button" value="0"/>
<input type="button" value="Apply & Reboot"/>				

ST2022-7 mode

Anubis SPS model will show a ST2022-7 setting.

Refer to the Anubis User Manual ST2022-7 chapter for all details

Obtain an IP Address

Manual: Tap the address field you wish to edit and select the value using Anubis rotary knob

Auto: The IP address will be automatically attributed using ZeroConf/Auto-IP mechanism (address range 169.254.x.x if no DHCP server is present)

Note: By default, the Anubis IP setting is set to "Auto" configuration mode

For details on the Anubis SPS model refer to the SPS Manual section [here](#).

IP address

Set the IP Address for the Anubis unit by using box selection and changing the value using the Anubis rotary knob. Available only with IP Settings = Manual

Default: 169.254.x.x

Subnet mask

Set the Subnet Mask (subdivision of an IP network) for the Anubis unit by using box selection and changing the value using the Anubis rotary knob. Available only with IP Settings = Manual

Default: 255.255.0.0

Default gateway

Computer network node using the Internet Protocol Suite that serves as the forwarding host to other networks when no other route specification matches the destination IP address of a packet

Default: 0.0.0.0

Apply & Reboot

Once changes have been made to this section, you must press this button to save the settings

and power cycle the Anubis unit, shutdown and reboot.

Date & Time

Anubis includes a real-time clock that is battery powered even in the absence of external power.

DATE & TIME	
TimeZone	Europe/Paris
Date	29 / 4 / 2019
Time	11 : 3 : 49

TimeZone

Select your local timezone from the dropdown menu

Date

Set the date by tapping each field (Day: Month: Year) one by one and using the Anubis rotary knob to adjust it.

Time

Set the date 24-Hours format by tapping each field (Hours: Minutes: Seconds) one by one and using the Anubis rotary knob to adjust.

Note: The Date and Time changes will be saved once you exit the Anubis Settings or if you Save the current configuration from Settings>Exit>Save

I/O Settings

INPUT SETTINGS

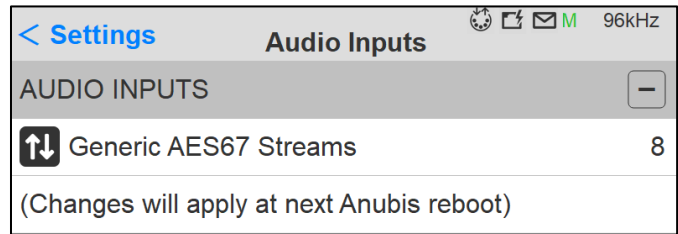

Generic AES67 Streams support

Range 0 to 48 channels

Allows users to connected AES67 compatible devices with the Music Mission in order to have those devices input streams available in the Anubis Mixer.

Procedure:

1. Select the Generic AES67 Streams line and with the Anubis rotary encoder enter the channel count you wish to use.
2. Exit Settings and then Reboot Anubis to apply the Generic Streams
3. On your system open ANEMAN (download and install if not already running) or the RAVENNA Advanced pages. Refer to the RAVENNA Advanced pages.
<https://confluence.merging.com/pages/viewpage.action?pageId=33260125>
4. Within ANEMAN generic AES67 streams will be available for connections.
5. Once the connections are made the generic streams inputs will appear online in the Mixer.

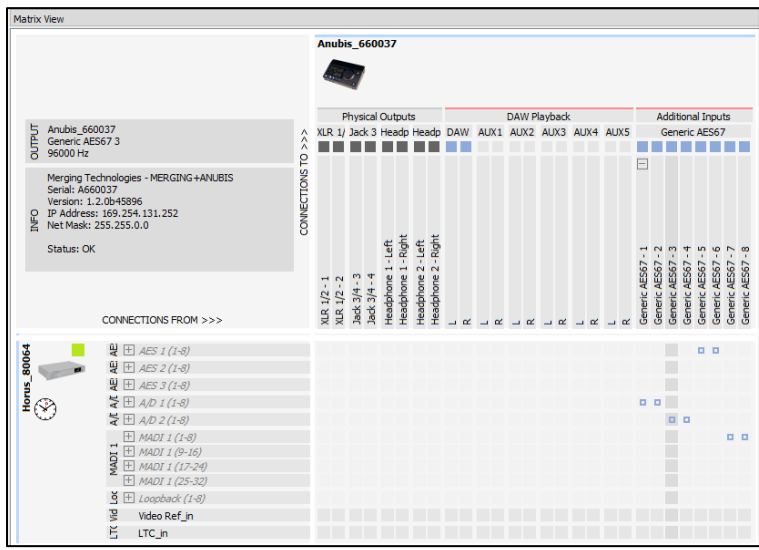

OUTPUT SETTINGS

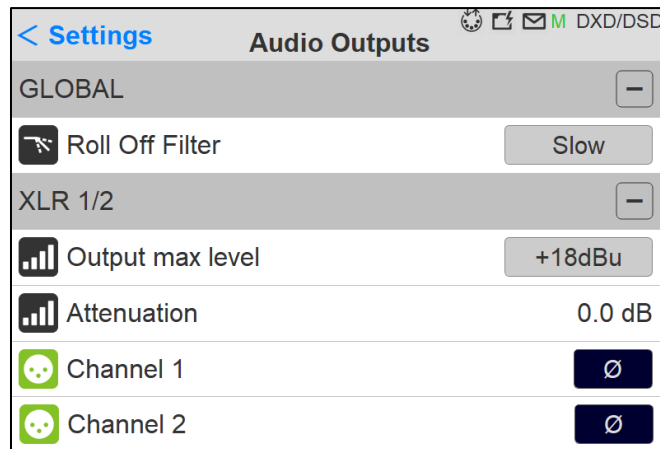

Global Outputs Setting

Roll Off Filter:

Sharp: Offers a flat frequency response with an attenuation of 3 dB at $0.484 \times FS$ (23.2 kHz @48k), which has the tradeoff of 35 samples latency.

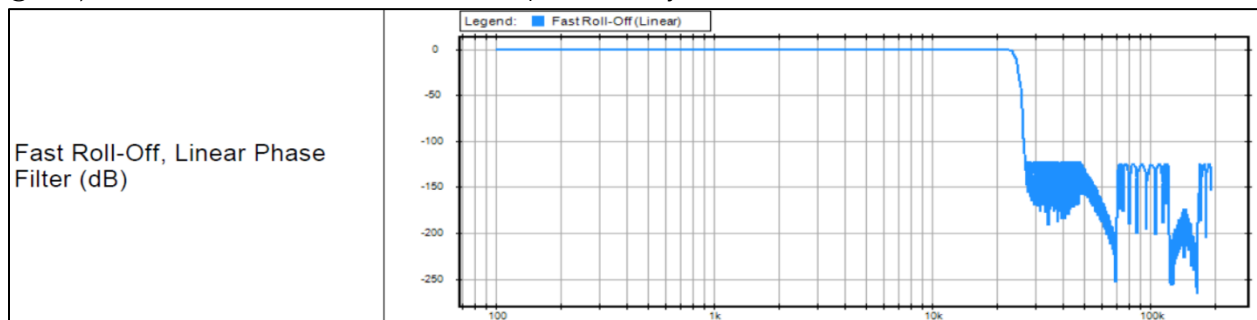

Slow (default): Offers the lowest latency of 9 samples, with the tradeoff of a gentle frequency response attenuation reaching -3dB at $0.45 \times FS$ (21.6 kHz @48k)

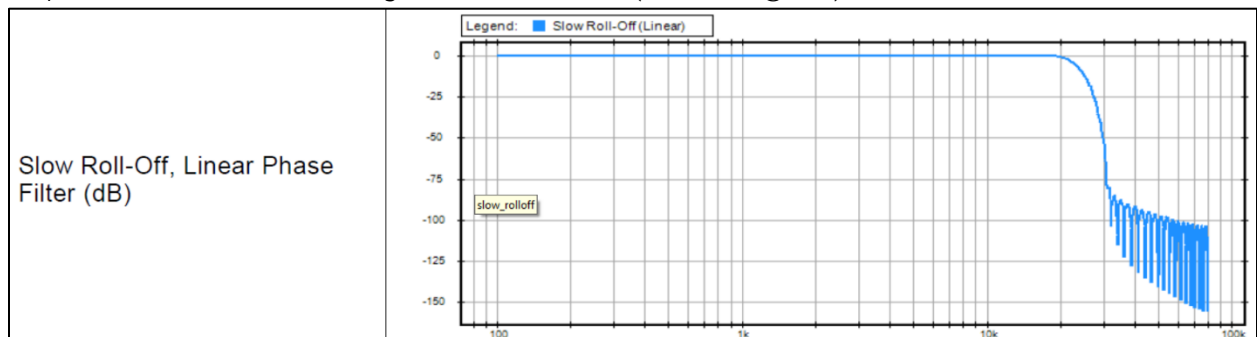

Apodizing: Fast Roll-Off filter, Linear phase filter. Latency of 35 samples

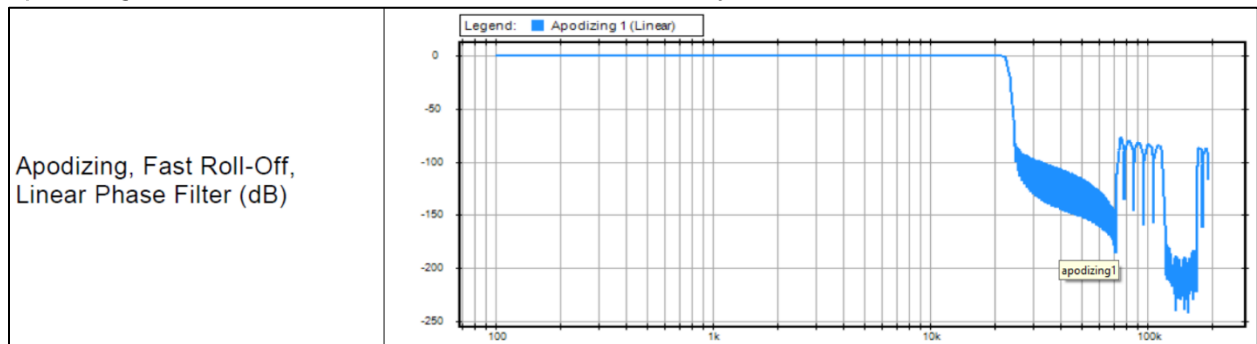

Brickwall: Ensures rejection of more than -100dB at Nyquist (0.50 x FS, 24 kHz @48k). Latency of 35 samples

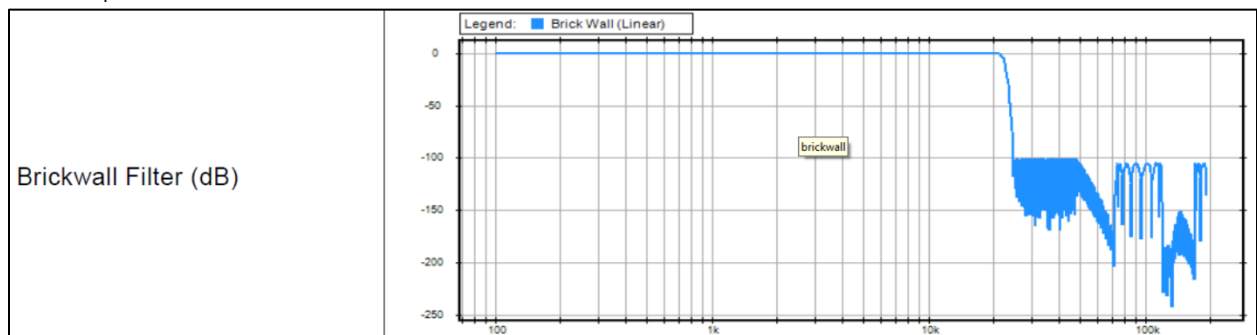

XLR 1/2: Line output level of the physical XLR outputs 1 and 2 located at the back to the Anubis

Max Output Level: +18dBu or +24dBu

Attenuation*: +0dBu or -36dBu

Channel 1: Polarity setting

Channel 2: Polarity setting



Warning: Please refer to the section on [How to connect a balanced line output to an unbalanced input](#) regarding Max Output Level limitation.

JACK 3/4: Physical TRS jack outputs 3 and 4 located at the back to the Anubis

Same parameters as above (XLR 1-2)

HEADPHONE 1: Headphone set 1 located at the front Anubis left side

Max Output Level: +9dBu or +18dBu

Attenuation*: +0dBu or -36dBu

Channel 1: Polarity setting

Channel 2: Polarity setting

HEADPHONE 2: Headphone set 2 located at the front right side of the Anubis

Same parameters as above (Headphones 1).

The Anubis digital to analog converters are designed to drive high or low impedance headphones at high levels with significant audio output power undistorted.

User should be attentive to the impedance of the headphones being used and set the Anubis Max Output level accordingly.

Warning: *It is not recommended for headphones with an impedance below 200 Ohms to select an Output Level of +18dBu. As a preventive measure, a warning message will be displayed each time a user changes the Output Level of the Headphones from +9dBu to +18dB*

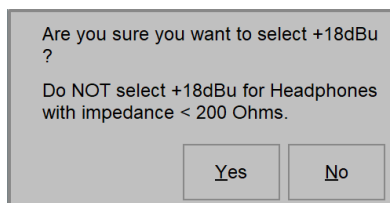

Warning: *The Anubis Headphones output level can make your headphones very loud if it is turned up too high, and that could cause permanent hearing damage. Please be careful with your ears when using the +18dBu setting.*

**As of Firmware 1.0.16 and higher. The Settings>Audio Outputs page no longer have per channel output trims. This was replaced by an Attenuation feature for the output pairs. Trim / channel have to be done in the Monitor from now on.*

TRIGGERS SETTINGS

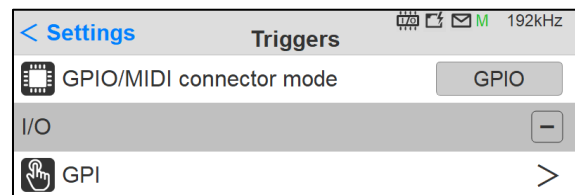
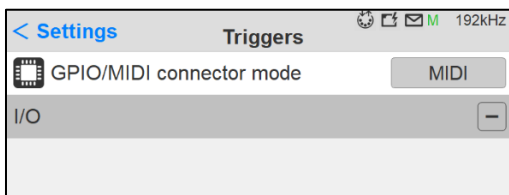

The triggers setting provides 2 different operation modes.

1- MIDI: Musical Instrument Digital Interface protocol that connect a wide variety of electronic musical instruments, computers, and related audio devices (e.g. remote MIDI keyboard or MIDI sound device)

2- GPIO: General-purpose input/output for studio example record light control (GPO) or remote pedal controls such as footswitch (GPI).

MIDI or GPIO Selector: Switch between MIDI (default) or GPIO. Users can select either MIDI or GPIO and cannot combine one with the other.

MIDI mode:

Connect a Keyboard MIDI Out -> Anubis MIDI IN and via RAVENNA/RTP or configure your MIDI so that your keyboard triggers DAW VST instruments. The DAW source stream is then monitored from ANUBIS.

A DAW/MIDI program can also return a MIDI out signal, that could play a MIDI partition via the Anubis MIDI Out that would be connected to the MIDI Input of an external Synthesizer.

Requirements:

It is mandatory to use a MIDI Jack ¼ with the proper pin out (details in the Specifications section of the Anubis User Manual). Such cable is available on the Merging pricelist, refer to your closest Merging Sales partner for ordering.

MIDI Setup Procedure.

The MIDI ports will be available in your computer once the Anubis drivers are installed and once you've followed the PC or Mac procedure here.

<https://confluence.merging.com/pages/viewpage.action?pageId=61309057>

Status: in the Anubis Taskbar the MIDI indicator for input and output, will light if MIDI is received or transmitted.

GPIO mode:

Enable the GPIO mode in order to use those I/O (located at the back of the Anubis), by doing so two new entries, GPI and GPO will appear in the Triggers Settings.

Note: GPO not yet available, under development.



GPI Settings

Enter the GPI page in order to configure the GPI triggering function type and triggering modes.

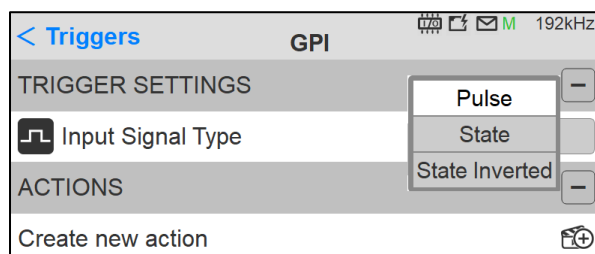

Pulse: Action is executed when the (foot)switch moves from close to open state.



State: Action is executed when the (foot)switch moves to open state. Actions in Toggle mode will reflect the state as follow: open = on, close = off

State Inverted: Action is executed when the (foot)switch moves to close state. Actions in Toggle mode will reflect the state as follow: open = off, close = on

Create a new GPI action:

Tap on Create new action line to create the action and from this o determine what will be the triggering action



 Created actions are by default enabled, but users can disable an action at any time 

 Select to delete an action

Status: In the Anubis Task Bar the GPIO indicator for input and output will light if GPIO is received or transmitted

Group: A fixed list of Group options is available

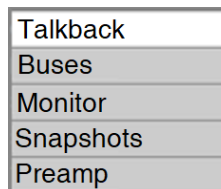

Component: Will vary with the Group option selected.

Function: Will vary with the Component option selected.

Action: Toggle: Action will toggle between ON and OFF

On: Action will be turned ON (only)

Off: Action will be turned OFF (only)

Trig: Applies the action at every triggering

Note: In the example here left, a footswitch will trigger the PreAmps Cut option On/Off in order to use this one as a cough pedal.

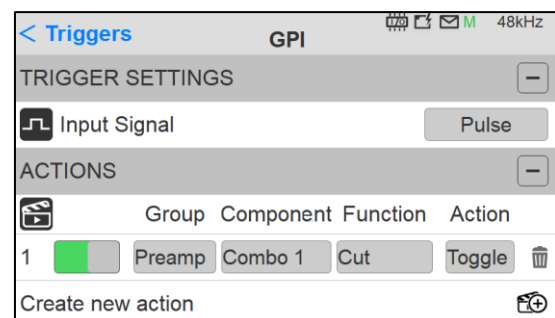

GPI Table:

Group	Component	Function	Action	Description
Talkback	Cue 1 to Cue 5	Talk	On/Off/Toggle	Talkback behavior actions
Buses	Mixer	Mute	On/Off/Toggle	Output Buses behavior actions
	Mixer-ALT	Mute	On/Off/Toggle	
	Cue 1 to Cue 5	Mute	On/Off/Toggle	
Monitor	MIX-A	Mono	On/Off/Toggle	Monitors behavior actions
	MIX-B	Mono	On/Off/Toggle	
	MIX-B/B	Mono	On/Off/Toggle	
Snapshots	Recall	Next/Previous/1-18	Do	Snapshot recalling actions
Preamp	Combo 1	Cut/Highpass	On/Off/Toggle	PreAmps inputs actions
	Combo 2	Cut/Highpass	On/Off/Toggle	
	Jack 3	Cut/Highpass	On/Off/Toggle	
	Jack 4	Cut/Highpass	On/Off/Toggle	

MUSIC SECTION

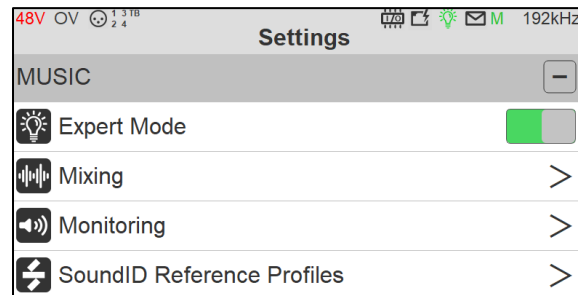

Expert Mode

The Anubis Music Mission includes two operating modes. The Default mode (simplified) and the Expert mode (more advanced and complex). Switch at any time within seconds by enabling or disabling the Expert Mode under the Music Settings.

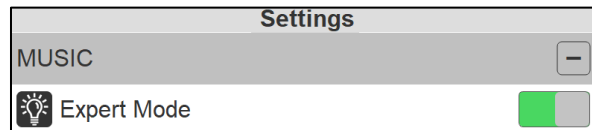

Operating Mode Features

Default mode (Simplified)

- Fully operational for an engineer/musician with an additional performer
- Built-in Reverb, EQ, Dynamics with quick rotary control view
- 1 x CUE and 1 x SEND available
- CUE Monitoring controls for 1 CUE
- Fewer menu options
- Fewer configurations and potential setup errors

Expert Mode

- 5 x CUES and 3 x SENDS available
- CUE Monitoring controls for all 5 x CUES
- Quick Rotary view display expanded for all 3 x SENDS
- Full Fader view for all SENDS including Reverb and Dynamics Buses
- Mixer Setup Page to customize the mixer channels layout
- Peering support for additional I/O's and quick expansion

The Anubis top taskbar will show a light bulb as an indicator when the Expert Mode is running

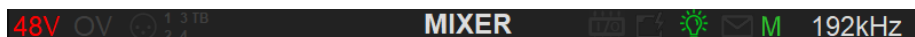

MIXING Settings

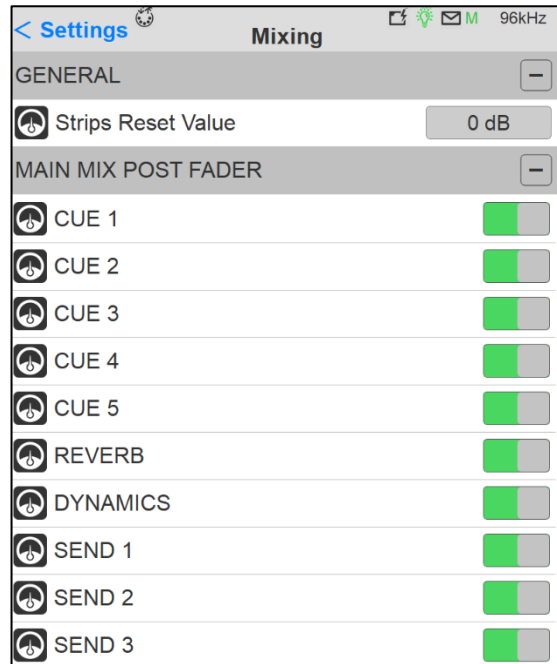
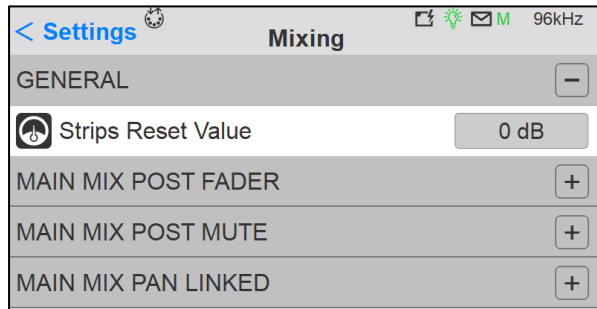

Strips Reset Value

Resets the faders to a set value. This setting will be applied when performing a Bus “Reset” (from the mixer top Menu” and to any new Peered Strips
Range: 0dB or - ∞ dB.

MAIN MIX POST FADERS:

When enabled all channels in REV, DYN and SENDS busses are sent post Fader of the MIX Faders.

Faders of the REV, DYN and SENDS still apply and are added to the MIX Faders values.

MAIN MIX POST MUTE:

When enabled all channels in REV, DYN and SENDS busses are sent post Mute of the MIX Mute.
Mute of the REV, DYN and SENDS still apply and are added to the MIX Mute state.

MAIN MIX PAN LINKED

Default: All Pans are linked to the Main Mixer.

The operator can decide if the PANS of the Cues, Effects and Sends he operates are linked to the Main Mixer or not.

With Link mode enabled, the Main Mixer Pans will be applied to all the Linked items (Cues, Effects and Sends) so that the operator does not need to redo his panning multiple times, for each Cues, Effects and Sends. This mode of operation is similar to a mixing console workflow.

With Link mode disabled, a Cues, Effects and Sends will have their own panning values, thus different to the Main Mixer if one wishes.

MONITORING Settings

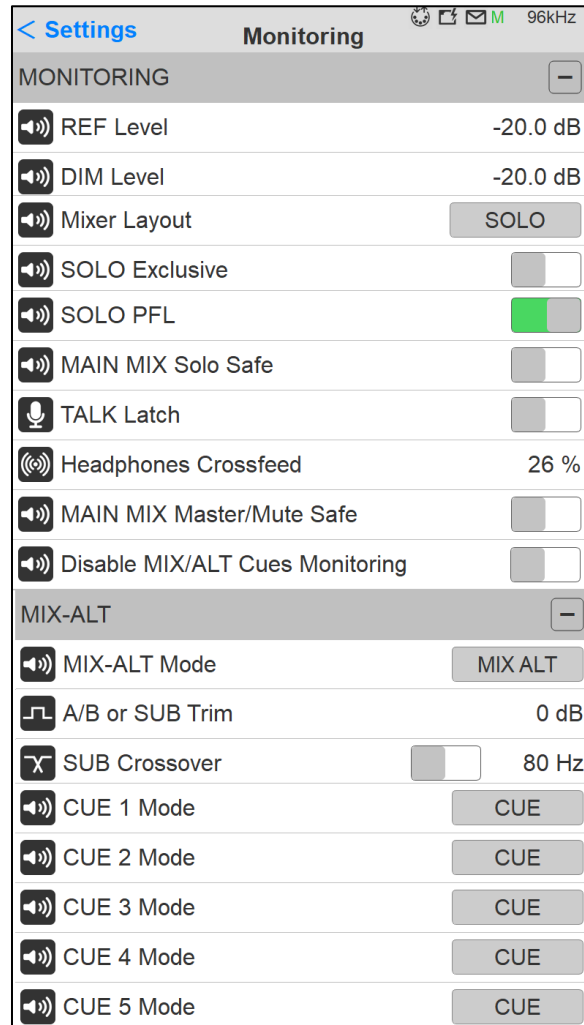

The Monitoring settings page allows the user to configure the monitoring options and behaviors.

REF Level:

Determine the Reference listening level you wish to establish when recalled. Set the level by using the Rotary Knob.

Range: -144dB to +6dB

Default -20dB

DIM Level:

Set the desired Dim level value by using the Rotary Knob. The Dim attenuation is applied to the current volume value of a Speaker Set (*Dim does not apply to headphones or cues monitors*). Apply the Dim from the Main Pages Monitoring controls.

Range: -60dB to 0dB

Note: Ref and Dim only apply to Speaker Set Type of Monitor Modes

MIXER Layout:



Select if you wish to display Solo or Mute on the Anubis TFT Mixer. This setting allows the user to swap the display of SOLO or MUTE.

Default: Solo.

SOLO Exclusive:



When this option is enabled, the action of Solo on a selected channel strip on the Anubis Mixer will un-solo any other channel strip and will thus only Solo that channel. The solo exclusive will also be applicated to an entire Group if performed on the Group Master Channel

Default mode: Disabled

SOLO PFL:



When this option is enabled, the Solo will be pre-fader listen, thus not consider the fader level applied.

MAIN MIX Solo Safe:



When enabled all Solo performed on the Main MIX display are disabled, thus making the MAIN Mix output safe of Solos. Ideal for live situation to prevent accidental solos to MAIN MIX Output.

Under such mode the Soloed channels will be reflected on the MIX-ALT view, thus it is recommended for the FOH to be working with focus on the MIX-ATL.

TALK Latch:

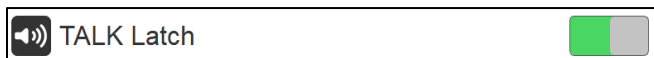

When enabled the Talkback within the Anubis Mixer will behave in Latch mode allowing the talker to press hold the Talk button for momentary talkback. Releasing the Talk button will automatically deactivate the Talkback.

Default mode: Disabled

HEADPHONES CROSSFEED

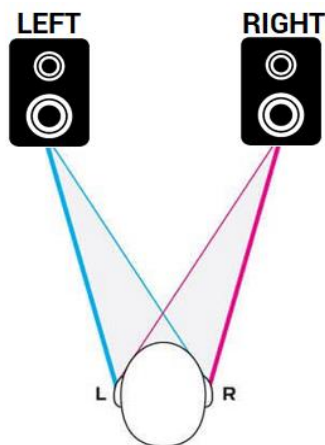

Crossfeed only applies to Headphones. It is the process of blending the left and right channels of a stereo audio recording. It is generally used to reduce the extreme channel separation when monitoring with headphones vs. speakers (e.g., where instruments are panned entirely on one side or the other). Apply Crossfeed to make audio played through headphones sound more natural, as when listening to a pair of external speakers. Select and turn the Anubis rotary knob to apply. Range: 0 (no crossfeed applied) to 100% (equivalent to mono).

To monitor the crossfeed simply applied your value and it will be monitored from any local Headphone set.

Note: Crossfeed is not supported on Peered Headphones and thus will apply only to the local HP1 and HP2 of the Anubis.

Anubis Settings>Monitoring. Headphones Crossfeed and replicate your speakers position using the %

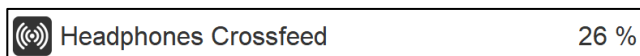

MAIN MIX Master/Mute Safe:

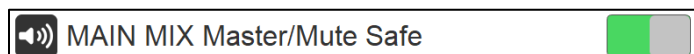

When enabled and when the Main MIX is displayed/selected, the default rotary behavior manipulating the Master Gain as well as the physical Mute button are disabled. They apply to the MIX-ALT bus instead.

Ideal for Live situation to prevent an accidental MAIN MIX Output level change.

Disable MIX/ALT Cues Monitoring



If the Disable M>C and C>M is active those options will be disabled and grayed out on the Anubis Cue Monitoring section and on the Web Access page.

Ideal in a Live situation to prevent by accident injecting Audio into the Main Mixer Bus and or by accident overriding the cue Monitors with the Main Mix.

MIX ALT- Multi Mode Mixer Alternatives

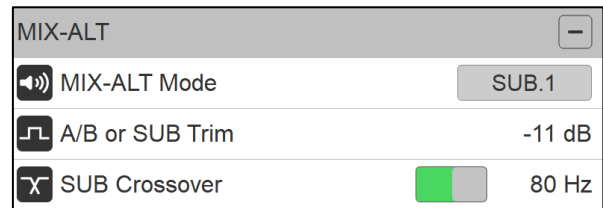
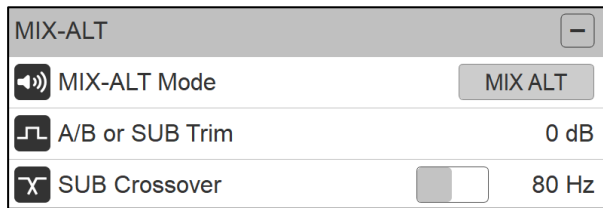

The Mixer Alternate offers multiple monitoring modes providing strait up monitoring for Headphones and extra Speakers as well Crossfeed for Headphones, support for A/B monitors sets and 2.1 or 2.2 Speakers layouts support.

Alternate Output

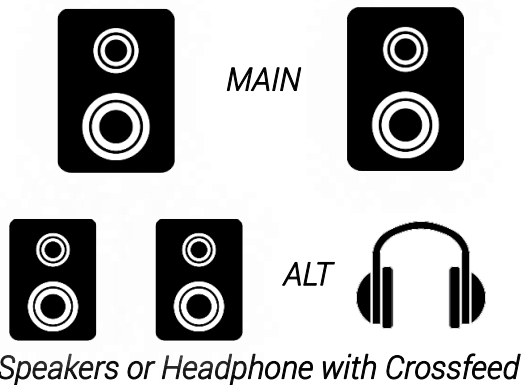

A/B Mode

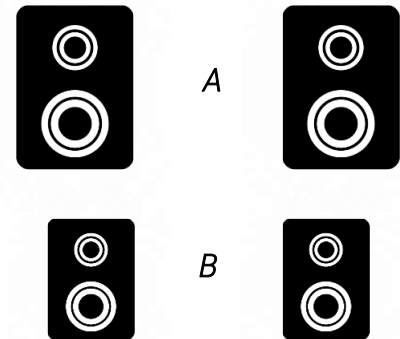

2.1 Layout

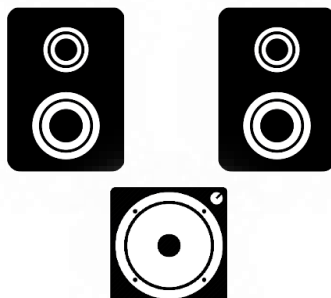

2.2 Layout

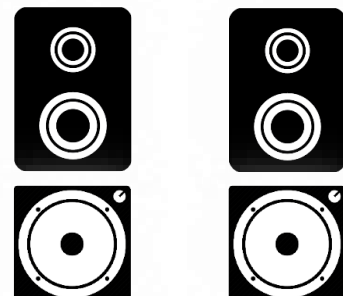

The MIX-ATL 4 modes

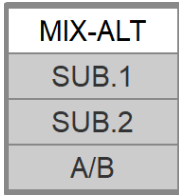

Different actions are applied to the MIX-ALT depending on the chosen mode.

Mode/Action	Solo	Mute	Fader	Pan	Master (Gain/Dim/Ref/Mono)
MIX ALT	x	x	x	x	
MIX A/B	x	x	x	x	
SUB.1	x	x	x		x
SUB.2	x	x	x	x	x

MIX-ALT

Anubis Standard Mixer Alternate monitoring. Share the same mixer as the MAIN MIXER but have an independent volume level.

Typical use is for monitoring the mixer with headphones and have independent volume control for the Headphones.

Default Output Routing: Headphones1

A/B or Sub Trim mode

For A/B Speakers set use.

Select the A/B mode typically if you have 2 sets of Speakers. One Reference and one Alternate Speaker set. This mode can also be used to switch between Speaker and Headphones monitors. In such mode the Volume Gain will be the same for both pairs of speakers sets. Toggling between the Anubis A button and B button will activate the proper speaker set at selection and mute the other speaker set.



When running in SUB mode a level Trim is available. Typically, useful to apply a SUB Boost.

SUB.1

For Sub setups (e.g. 2.1).

The Sub will monitor the same content as the Speaker Set A and have the same link volume.

SUB.2

For two Subs setups (e.g. 2.2).

The Subs will monitor the same content as the Speaker Set A and have the same link volume.

The Panning will be L-R within the Subs.

SUB Crossover:

A crossover parameter can be enabled and configured for Bass Management

Frequency Range: 20Hz to 1000Hz

The crossover uses 1 EQ out of the 21 EQ available in Anubis

CUES Modes

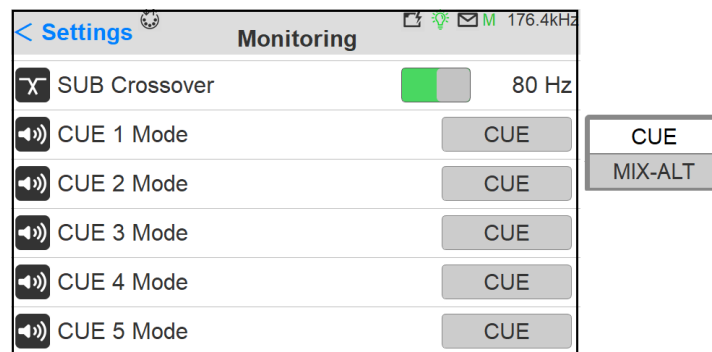

CUES can operate in CUE mode where you have independent mixers for each CUE or in Mixer Alternate (MIX-ALT) mode where the Cue Mixer is a replica of the Main Mixer, but will have its own Master Gain and Master Effects.

When in Mix Alternate mode the CUE will no longer appear in the CUE Monitoring section, and its right-side bar controls will be the same as the Main Mixer ones.

This mode can be useful in order to monitor the main mix out of different buses with an independent master gain.

SoundID Reference Profiles.

Import Sonarworks SoundID Reference correction into the Anubis

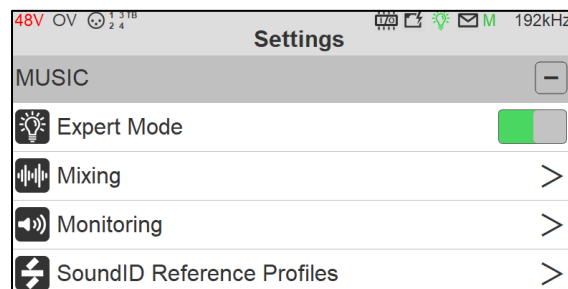

Refer to the Sound ID – Room Correction chapter below.

INFO Settings



Find all information about the Anubis Name, Type, Firmware version, Maintenance mode and Serial Number along with additional information on the Anubis status: Temperature, CPU and Memory usage.

< Settings		Info		48kHz	
Device's name				Anubis_Premium	
Type				Premium	
Firmware version				1.0.0b28910	
Maintenance Mode version				16	
Serial Number				A650041	
Boards run				Main: 3 Front: 3 UI: 3	
STATUS				-	
Temperature				26 °C	
Cores	0 %		37 %		
Memory				10 %	

Note: Anubis users should regularly check if a new firmware is available. It is important to update to the latest firmware in order to benefit from the latest improvements and fixes. Follow the firmware update procedure for all details.

DEBUG Settings



Loopback: Internal module with Generator (Supporting 1FS) and transparency check tool (Supported up to 384kHz). *Under Development.*



Enabling the Loopback will provide access to the Loopback module within the Anubis I/O's.

Note: The Loopback is for the moment only available as a debugging tool for the Merging Team.

EXIT Settings

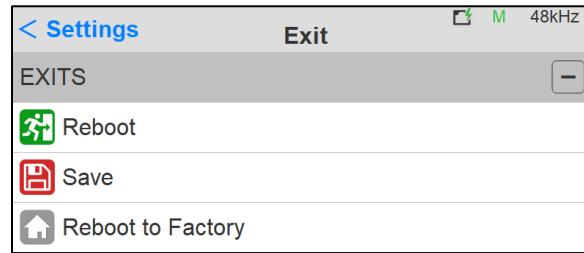

Reboot

Reboot the Anubis

Note: To turn OFF Anubis, press on the POWER button to switch it to the released state.

Save

Save the current Anubis configuration

Note: The Anubis entire configuration is saved every 2 minutes, and also every time you exit the Anubis Settings. If changes are applied when in the Anubis Settings and you plan to power off the Anubis while in the Settings, it is recommended to first perform a Save configuration.

Reboot to Factory

Reboot your Anubis to factory settings will recall the default factory settings.

 **Warning:** All Sources, Monitors and Settings will be lost.

Since the saved Presets will not be erased we recommend that you first back up your Anubis Configuration by saving it to a Preset.



Press the Anubis Home button to exit the Settings and return to the Mixer view.

ANUBIS ROOM CORRECTION WITH SONARWORKS SOUNDID REFERENCE

Sonarkworks SoundID Reference and Anubis integration

MERGING+ANUBIS is the first hardware to enable a SoundID Reference correction outside of the computer.

SoundID Reference (the next-generation version of formerly known Reference 4 software) is a speaker and headphone calibration software removing unwanted coloration and delivering accurate studio reference sound. With SoundID Reference you can stop second-guessing yourself and trust that every mix will translate. You'll hear a flat, consistent sound wherever you work from.

Upload your Sonarkworks SoundID profiles into the Anubis for Room or Headphone correction. Anubis will then correct your room and/or headphones and you will no longer need to depend on a system to be running for corrections.

Prerequisites

- Merging Anubis running the Monitor Mission or Music Mission
- Merging Anubis Firmware 1.2.5 and higher
- A full license for SoundID Reference (not applicable to trial versions), with version 5.1.0 (or later) installed. The latest update is always available for download [here](#).
- Install SoundID Reference and Measure for Room Correction or to export Headphones profiles.
- Sonarworks SoundID outputs should be configured with MAD or VAD.
- The Exported Profile can only be re-imported in the Anubis of the same serial number.

Warning: The SoundID Reference correction can be used from 44.1 to 192 kHz. Support for 352.8kHz (DXD) and 384kHz is planned in a future firmware release (post 1.2.5). DSD is not supported.

Procedure

1. Download and install Sonarworks SoundID reference and Measures (Room Correction option)
2. Configured SoundID to run on the Merging VAD (mac) or MAD (PC), by selecting "Add Output"
3. Select either ASIO for Merging Audio Device (MAD-PC) or the Merging RAVENNA/AES67 (VAD-macOS) As per image below.

Example: MAD (PC)

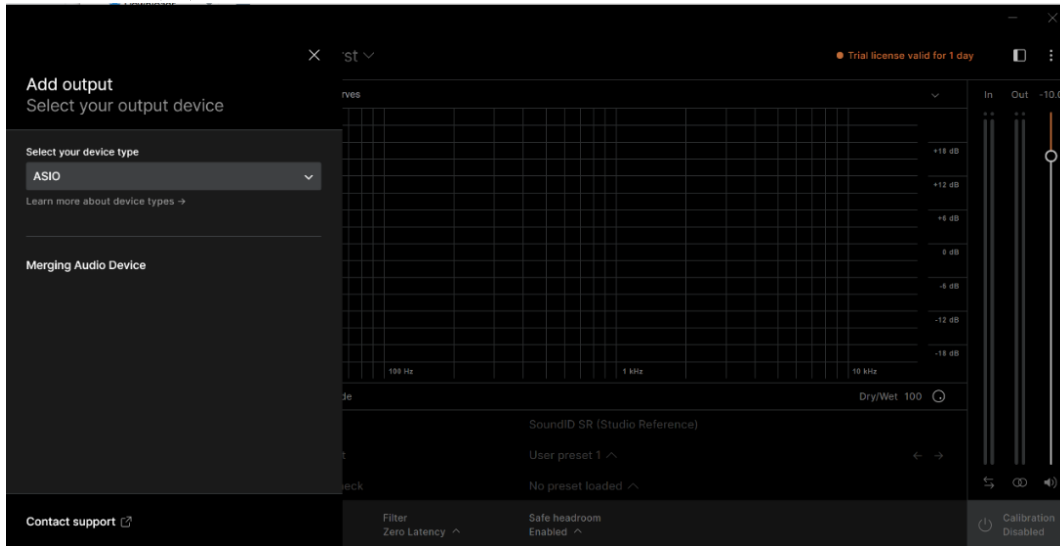

Note: The "Play a tone" test might not work on some systems (known SoundID case).

4. Create your Speaker Profile or Select the Headphones profile, follow the Sonarworks documentation and tutorials for this part.

[Speakers SoundID Setup](#)

[DAW and Headphones SoundID Setup](#)

SoundID Reference Measure (Room Correction):

If creating a new Speakers Profile it will be important that in the SoundID Measures you select the Anubis Mic input and the configured DAW outputs, as per image below (MAD IO or VAD IO).

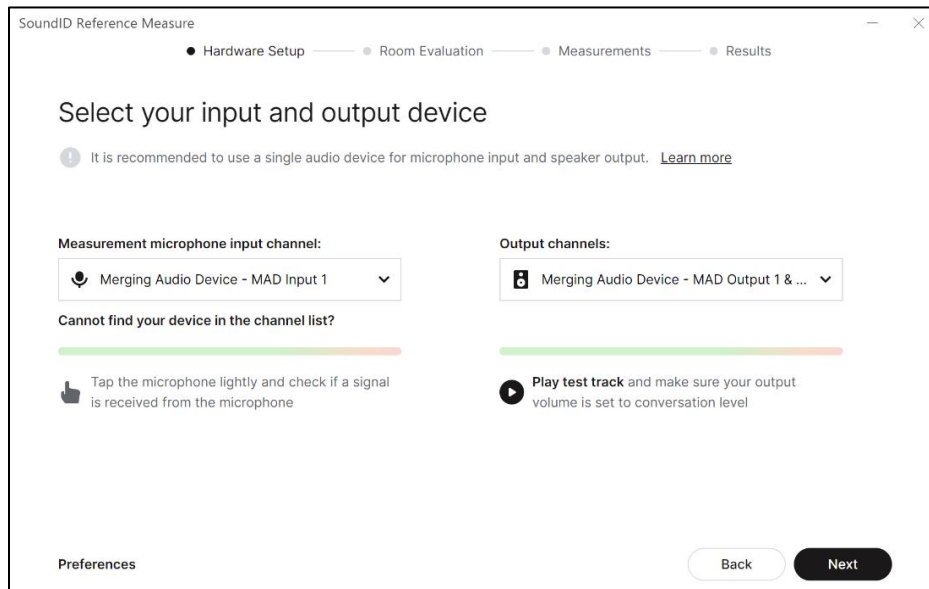

5. Once your Profiles are generated within SoundID select the profile itself and “Export”

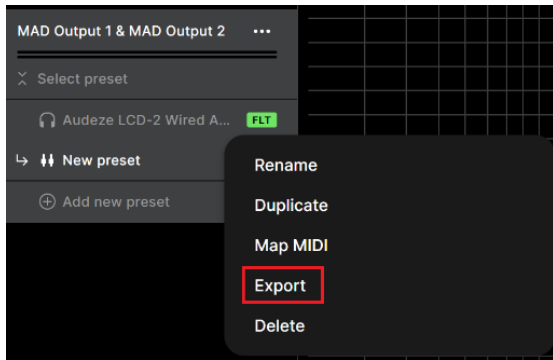

6. In the prompt dialog select the Merging Technologies (Audio Interfaces) entry

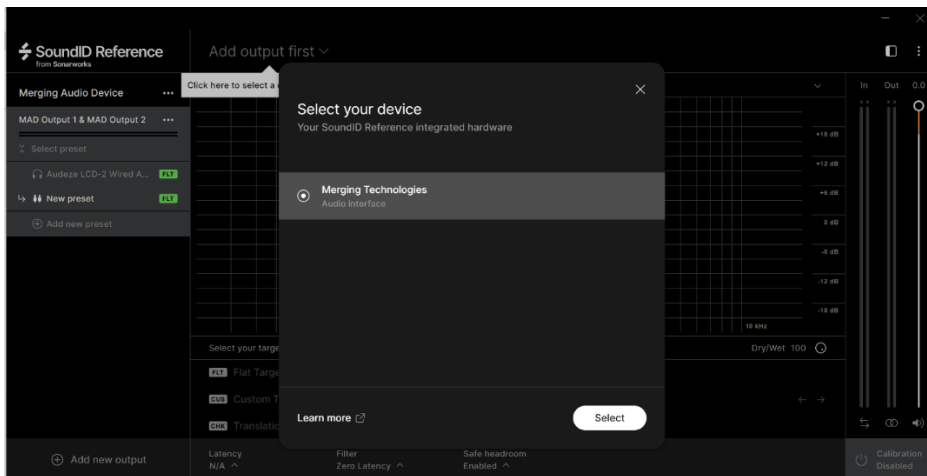

7. Enter your Anubis serial number. The serial can be found at the bottom of the Anubis or under Settings>Info page -> AXXXXXX

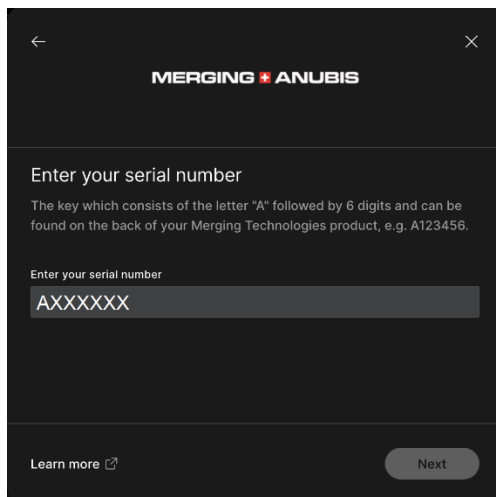

Note: Anubis does not need to be connected, but the exported serial must match the Anubis serial that will re-import the profile.

8. Carefully take note of the exported SoundID profile path. Browse if you wish to change the export destination folder.

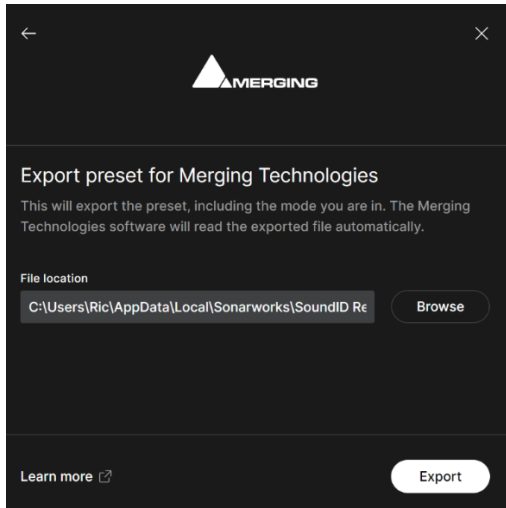

9. Once having Exported the profile to your system, disable SoundID and/or close it.

10. To Import the Preset Profiles in Anubis launch the Anubis remote Web Access page. From the MAD, VAD or ANEMAN double mouse click on the Anubis Icon.

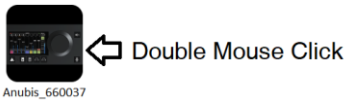

11. The Web Access will open, at the top left under menu select "Upload SoundID profile" in order to import the profile into the Anubis

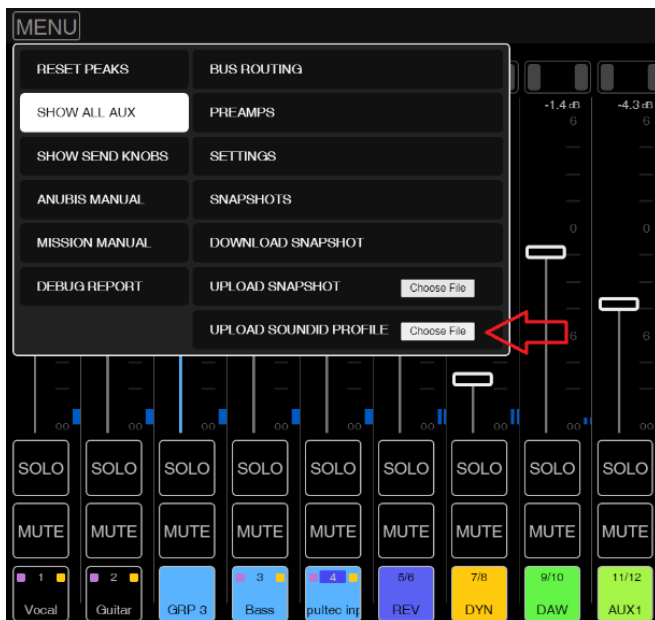

Music Mission Web Access

12. The profiles have now been imported into your Anubis. To manage (rename, delete) the Profiles go to settings>SoundID Reference page

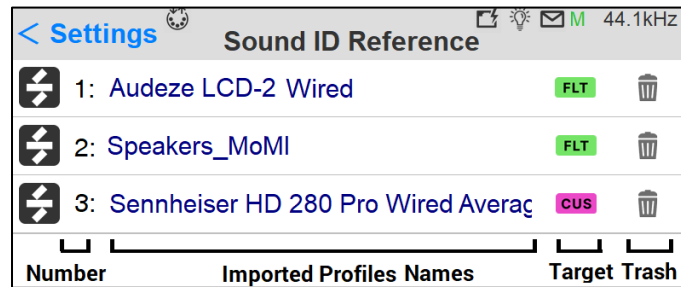

Number: The Profiles are sorted in alphabetical order

Name/Rename: Tap the profile name, to open the virtual keyboard and rename your profiles

Target: Target mode of the SoundID profile

- **Flat:** Flat target curve, based on neutral speakers in a treated room. SoundID SR (Studio Reference) defines the sound target for all Headphones.
- **Check:** Simulate specific listening environments or device
- **Custom:** Adjust the target curve or limit calibration to a specific frequency region

Delete: Tap the trash can icon next to the profile to delete this one.

Music Mission SoundID management

Find below how to apply a SoundID profile in the Music Mission. At first make sure that Profiles were imported into the Anubis as previously explained in this document.

In the Music Mission the SoundID profile will be applied to the Mix Bus Outputs, thus applied to any local physical output or peered devices outputs.

Restrictions:

- SoundID profiles can be applied to a maximum of two Reference Corrections simultaneously (Speakers or Headphones).
- The Music Mission Cues do not support SoundID profiles, use the Mix and Mix-ALT to apply Sound ID profiles.
- If a SoundID cannot be applied, disable some or your EQ resources, from either your Strips or Bus EQ.

1. Select the Music Mission Mixer Menu and tap the SoundID Reference entry to either the Mix or Mix-ALT Buses.

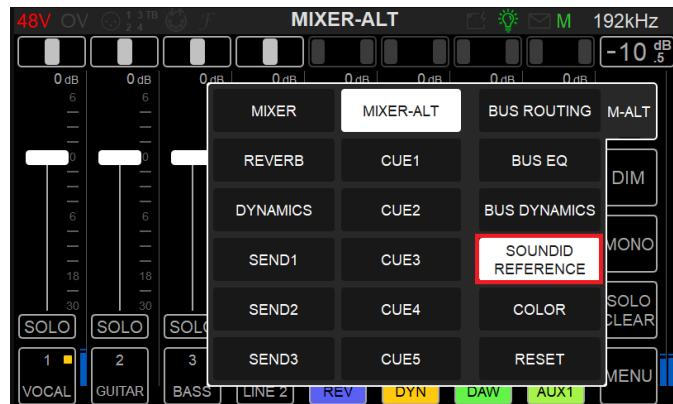

Note: if the SoundID Reference entry is greyed out it is because you have yet to import a Profile into the Anubis. Make sure you have first followed the procedure above.

2. Select the SoundID Reference Profile you wish to apply to this Mix Bus

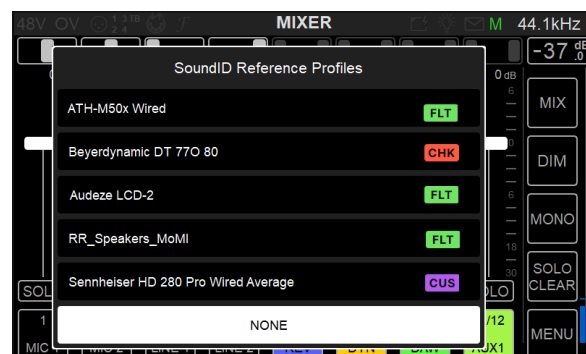

3. Once the profile has been selected find the Logs identifications here below.

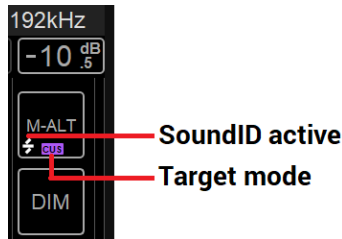

You should now be set for Room or Headphone Correction with SoundID profiles and can at anytime; enable, disable, re-import or manage new profiles.

Anubis SoundID Remote Access:

Applied or disable your SoundID Profiles remotely from any Web Browser (Google Chrome recommended). The Anubis Remote Control App withing the VAD-MAD options is also supported.

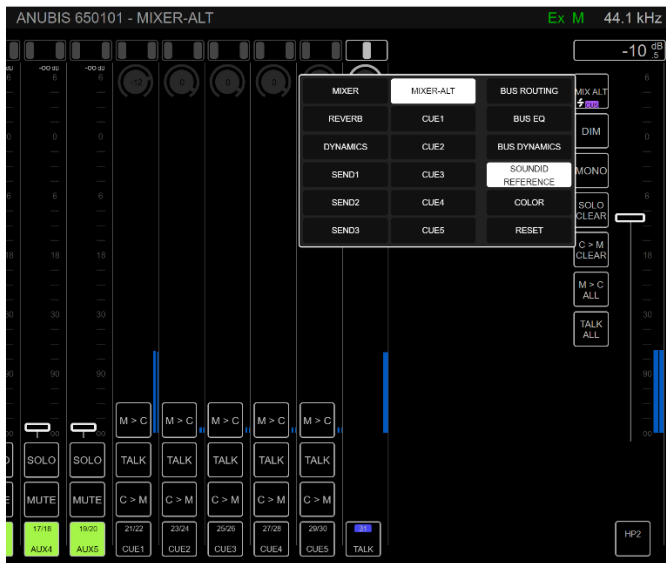

Web Access Remote

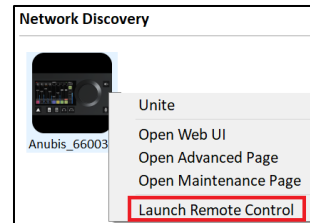

Remote Control Application

SoundID integration latency table when enabled.

- 44.1kHz: 1.36ms
- 48kHz: 1.25ms
- 88.2kHz: 0.68ms
- 96kHz: 0.61ms
- 176.4kHz: 0.34ms
- 192kHz: 0.32ms

BASIC MUSIC SETUP

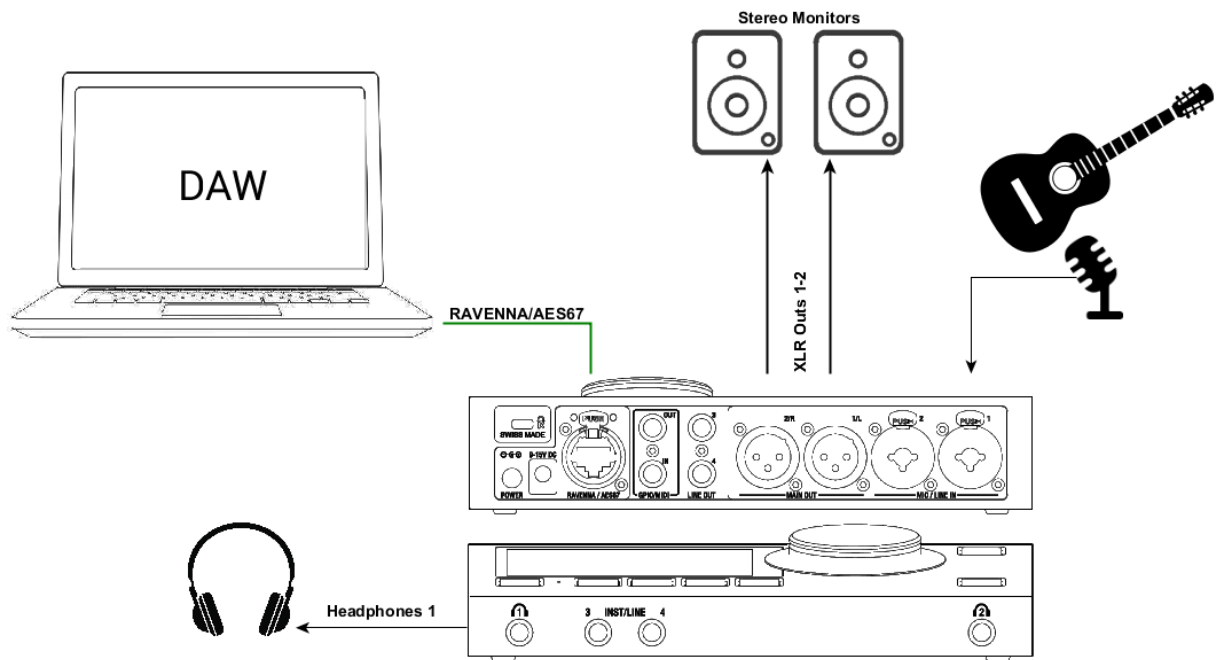

SetUp:

Using a Main Speaker Set and headphones in order to Monitor the DAW Main and instrument for playback or recording.

Prerequisites:

First follow the User Manual section on the Drivers Installation Procedure ([Drivers Installation Procedure](#)) and ensure that you have correctly connected and powered up your Anubis and have selected and launched the Music Mission.

Connect your Active Monitors (or Power Amp) to the Anubis physical Outputs XLR 1 and 2 and/or TRS outputs 3-4 if you have alternate Monitors in your setup. Then connect your microphone or instrument to one of the Anubis inputs.

Setup Procedure:

1. The Merging Audio Device (MAD – PC) or Virtual Audio Device (VAD – Mac) must be installed
2. Open the VAD or MAD panel and select the UNITE tab

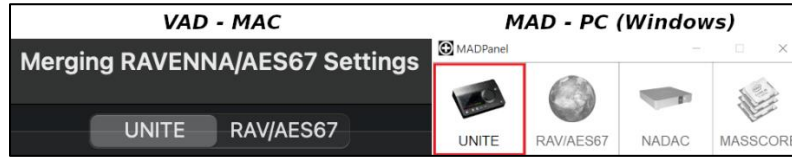

3. Click on the discovered Anubis (Connect your Anubis to your Mac or PC using the RJ45 Cat 5e or Cat 6 cable (RJ45).)

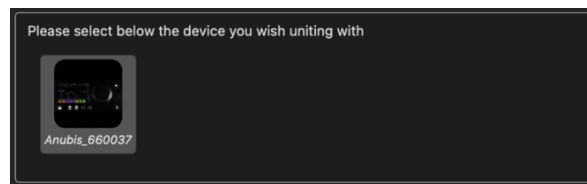

4. click Unite and select the elements you wish to connect



Physical input: We check those in this setup example as we are going to be recording the Anubis inputs.

DAW: by default is always checked, select the number of AUX (Software Playback) you wish to use.

More details on UNITE and connectivity can be found in our online database

<https://confluence.merging.com/pages/viewpage.action?pageId=86212613>

5. Launch your DAW or Application, has this one use our Merging RAVENNA/AES67 Drivers.
6. Connect the audio outputs of your DAW or software to the DAW (1-2) or AUXES (3-4,..) outputs.
7. In the Anubis Mixer you should have signal coming in the DAW or AUXES (Software Playback)
8. Mixed with this signal are your direct Anubis inputs, if you have connected a Microphone or Instrument, you will be able to mix those with the Software Playback (DAW)?

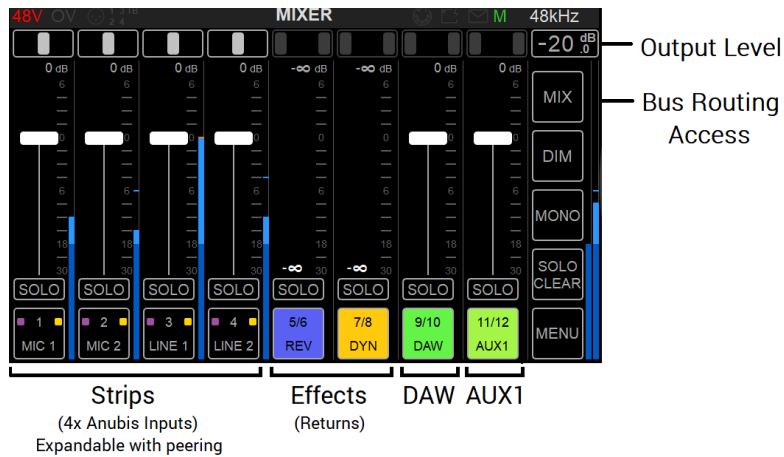

9. Open the Bus Routing Page and patch the Mixer and Mixer-ALT to the outputs you wish to monitor from.

Legacy (firmware 1.2.4 and prior)

New Bus Routing (Firmware 1.2.5 and higher)

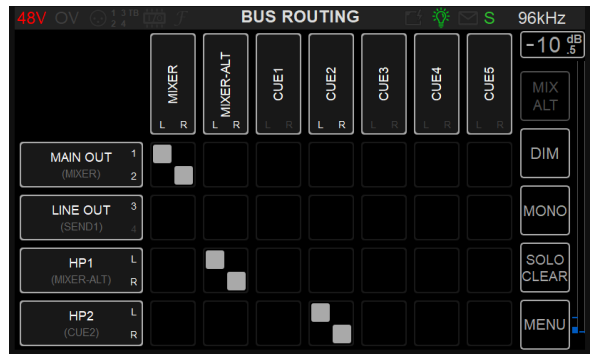
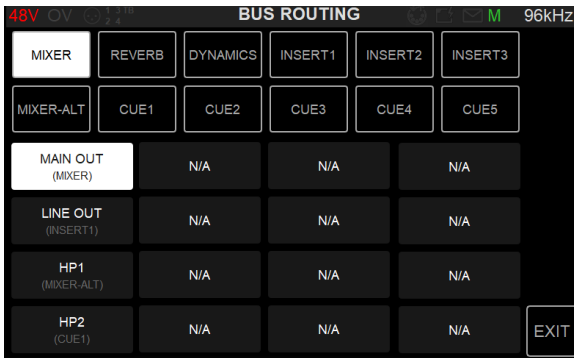

You are ready to Record and Monitor Software applications (DAW) using the Anubis Music Mission in which you can now Mix the Anubis Inputs channels in ultra-low latency.

RAVENNA/AES67 mode for more complex setups

For more complex set up, users can run the RAVENNA/AES67 mode (RAV/AES67 tab) where ANEMAN is required to make the connections. Users can choose and apply either a Multicast or a Unicast connection.

Unicast: from one source to one destination i.e. One-to-One (recommended for home Project Studio)

Multicast: from one source to multiple destinations stating an interest in receiving the traffic i.e. One-to-Many

Once the connections are applied the green connection will turn to either Purple (multicast) or Blue (Unicast)

Note: Make sure that both your Anubis and Driver are at the Same Sampling Rate and Latency Frame mode or on the same multiple set (e.g. AES67-48 samples or 64 Frame mode).

RECORDING SETUP WITH CUES

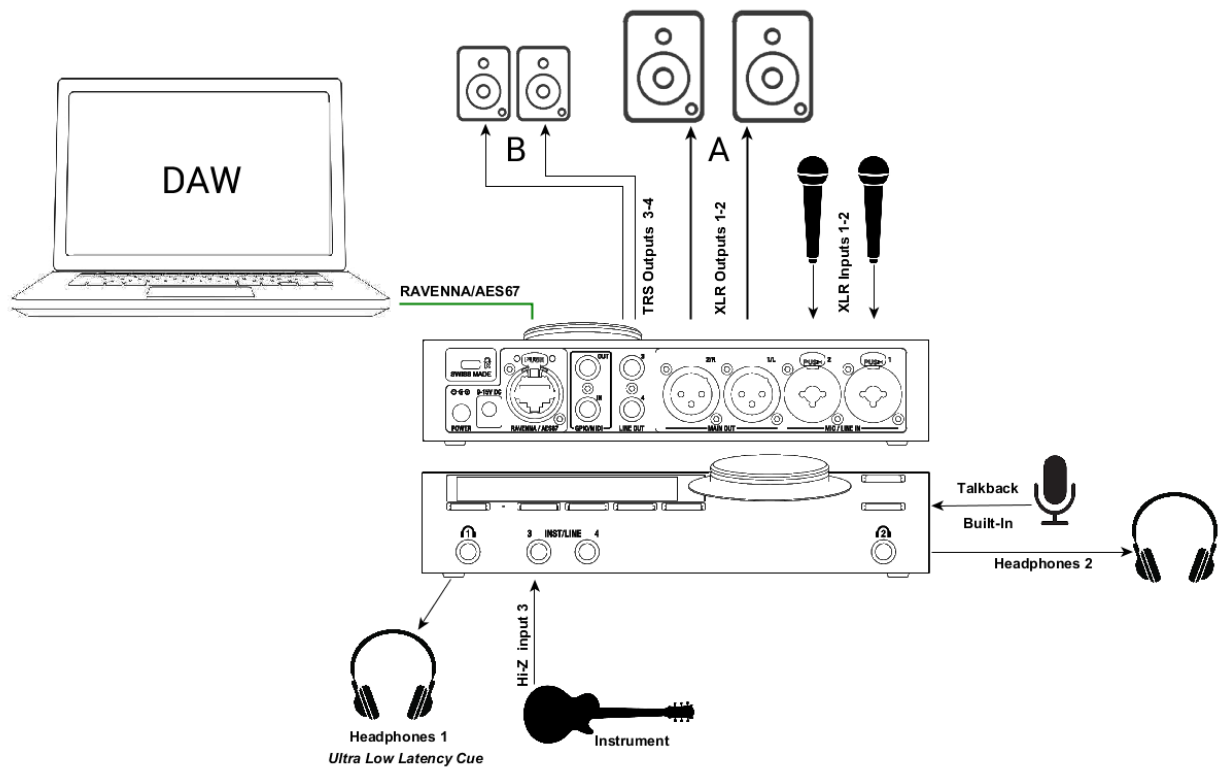

Setup:

Adding microphones and instruments for recording while monitoring your DAW Main outputs along with an ultra-low monitoring Cue routed to the Headphones.

Prerequisites:

Make sure you have first followed the User Manual section on the Drivers Installation and have correctly connected and powered up your Anubis.

Connect your microphones to the XLR combo inputs 1-2 located at the back of the Anubis, your Guitar or Bass can be directly connected to the Hi-Z instrument input at the front Input 3. Stereo inputs 1-2 or 3-4 can be used.

Note: Using Input 4 will override the built-in Talkback microphone as both share the same circuitry.

Using Ultra-Low Latency Cue

In this example we will setup a Cue for the performer foldback on the Headphones 1 Monitor set.

Note: Each Cue in the Anubis Music Mission has their own mixer that can monitor the Output sets of your choice. You can Monitor Cues with Speakers, Local Headphones and from Peered Devices that have output support (e.g. Hapi – Headphones)

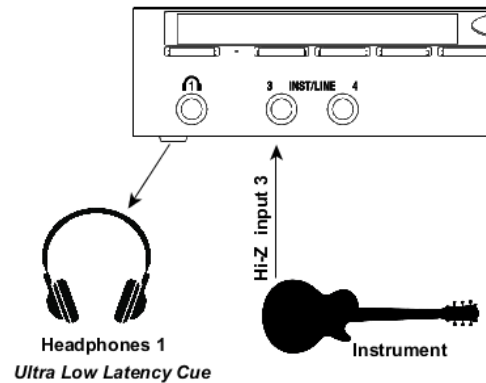

Procedure:

1. Proceed with a UNITE or ANEMAN to connect your DAW/AUXES Software Playback and any other I/O you will need.

More details on UNITE and connectivity can be found in our online database

<https://confluence.merging.com/pages/viewpage.action?pageId=86212613>

2. Connect your performer microphone or instrument to an Anubis input (or a peered device inputs)

3. Monitor your Anubis Mixer DAW, AUX and mix with it the mic or instruments input direct from inputs. It is recommended that you send back to your artist a foldback mix minus their input return to avoid phasing and latency issues.

4. Select the Cue 1 and go to the Bus Routing and patch this to the Headphones or Output channels pair that your performer will monitor from.

5. Make a Mix balance for your performer while you are in CUE 1

Example you can add Reverb on your direct inputs or EQ or compression.

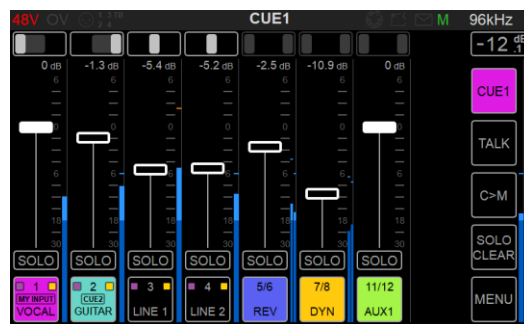

6. Record the performance in your DAW, while your performer will listen to the CUE Mix as an engineer you will monitor the Main Mixer.

To inject the recorded take back to your artist, use the M>C feature, to listen and prepare a Cue you can use the C>M feature.

You are ready to start recording with Anubis with a performer using an Ultra-Low Latency CUE.

HARDWARE INSERTS

Using Hardware Inserts with the Music Mission differs from using the integrated mixer sends, as the insert signal will fully pass through the external insert while the Sends are rather used for parallel processing.

Setup Main Use Cases

- Monitoring externally processed audio inserts
- Printing externally processed audio back into a DAW

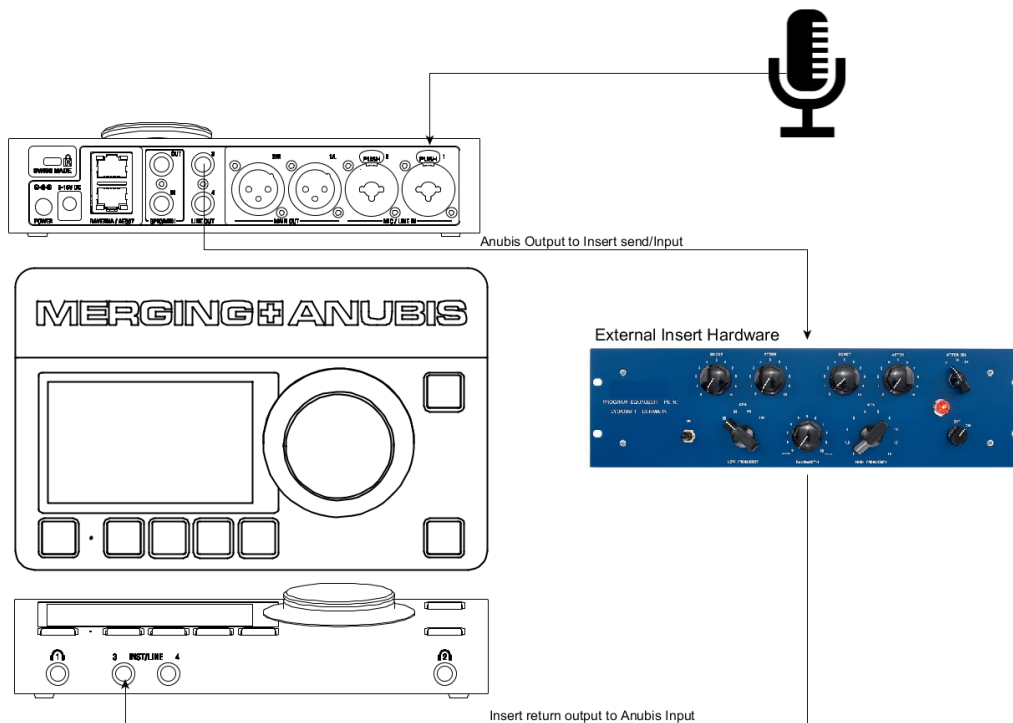

Find here below the procedure to accomplish external insert processing with the Music Mission. In the example here a microphone will be used as the source input. This one can as well go through an Insert to be recorded back with or without the Insert applied.

1. Connect a Source (A microphone is connected to the Combo input #1 here)
2. Connect your hardware insert input and output (the Pultec here in the example is a mono device and will be connected to single I/O channels). Users can additionally use stereo hardware inserts as well..
3. Enter the CUE1 from your MIX Menu

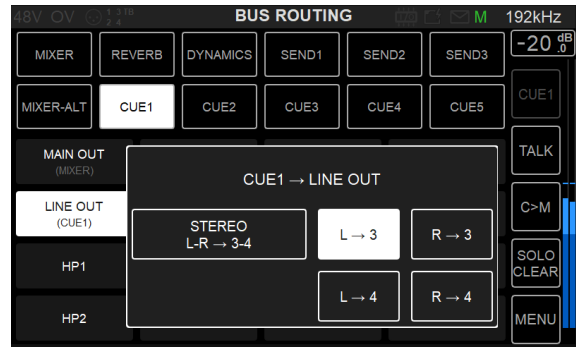
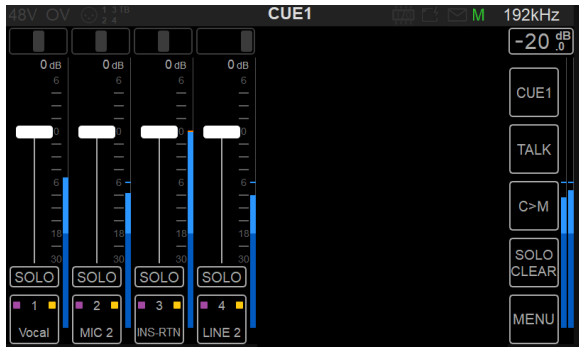

4. From there select the BUS Routing

5. Connect the CUE 1 outputs to TRS 3 output

6. In the CUE1 Page we recommend that you set the you set the CUE Output to 0dB to avoid any additional processing.

7. from the Main Mixer page the post insert which will return to Line #3.



8. The Line #3 input source level can be adjusted from the PreAmps Line input # 3

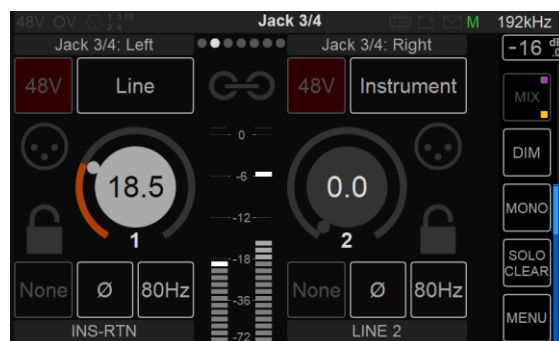

You are now ready to record your External insert return channel. It is common practice to record the direct Mic PreAmps channel #1 along with the Processed Hardware Insert #3 return.

MONITORING WEB USER INTERFACE

Remote control your Anubis Monitoring through any tablet or web browser by opening the Web User Interface page. The Anubis Monitoring Web User Interface combines all three pages of the Monitoring Mission into a single web page.

Peer to Peer Remote Access:

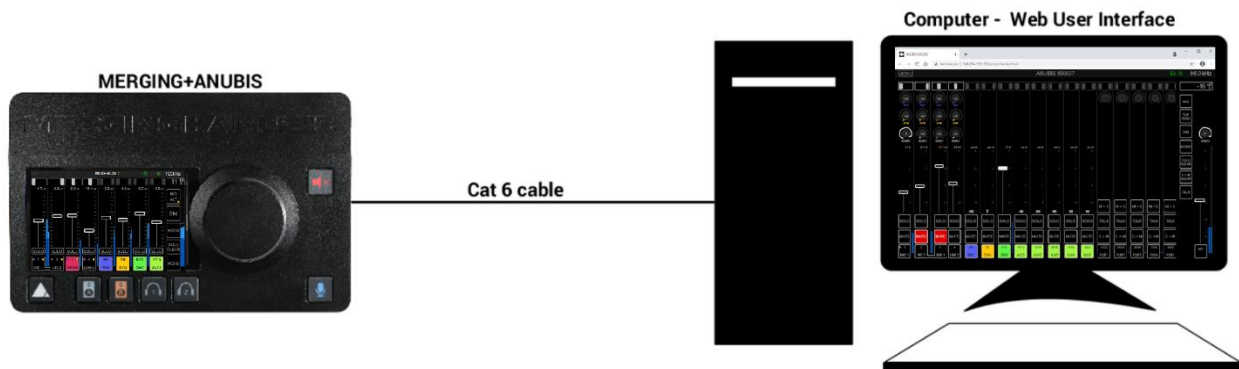

Network/Tablet Remote Access:

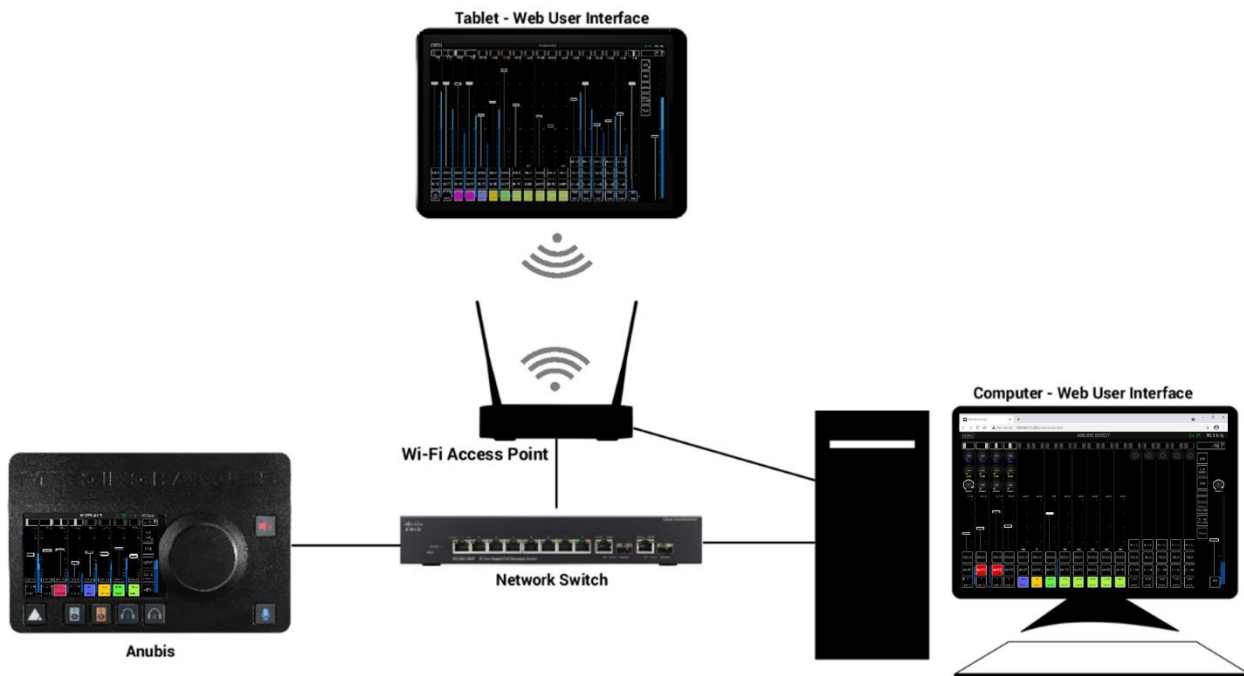

How to Open the Remote Web User Interface

PC Users:

Once Anubis is properly connected to your PC launch ANEMAN and double mouse click on the Anubis icon. This will open the Monitoring Web Access page in your default web browser. Users can also open the Web User interface page from MT Discovery by clicking on the Anubis entry.



Mac Users:

Once Anubis is properly connected to your Mac, open the VAD Panel and click on the Anubis Icon. This will open the Anubis Monitoring Web Access page in your default browser. Users can also open the Web User interface page from ANEMAN or MT Discovery by clicking on the Anubis.



Phone Users:

It is highly recommended to use a Kiosk app (ideal is the Kiosk Pro and the Pro-Lite is free)

Apple Store: <https://apps.apple.com/us/app/kiosk-pro-lite/id409906264>

Android: <https://play.google.com/store/apps/details?id=de.ozerov.fully&ql=PL>

Music Mission Web User Interface Page

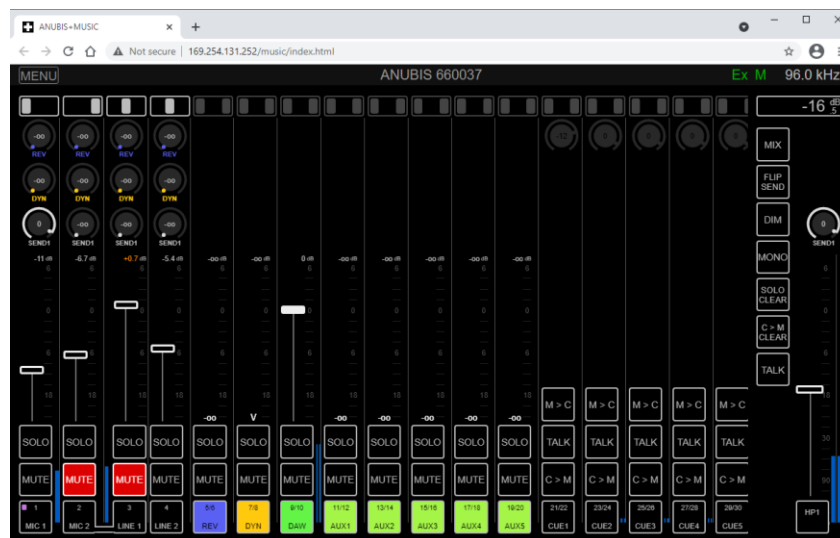

Web User Interface Page is a replica of the Anubis TFT display and allows the operator to remote control the Anubis from any web browser interface connected to the same network as Anubis

MENU Click on at the top left corner to display the Menu options

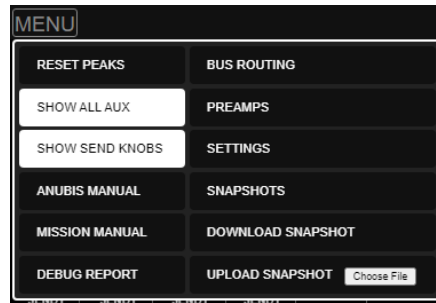

The Menu entries are similar to the Anubis TFT with the addition of the manual links and the Show Send Knobs.

Reset All Peaks:

Selecting this entry will reset the UI peaks in display

Show All Aux

When enabled, all AUXES (1 to 5) will be displayed in Mixer.

Show All Sends

When enabled, the Sends Rotaries will be displayed on the remote web access (browser) Reverb, Dynamics and Sends 1 to 3

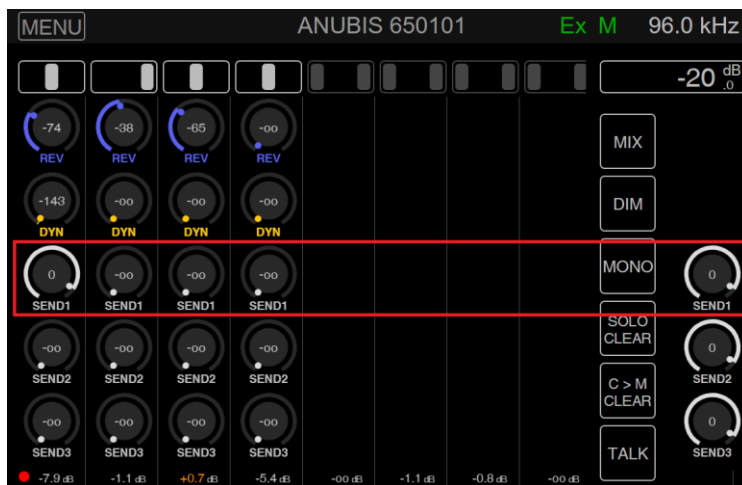

Note: Sends 1 to 3 include a Master Send level at the fast right of the Remote Web Access Mixer.

Anubis Manual:

Selecting this entry will open the Anubis User Manual that is embedded into the Anubis. Make sure you have a PDF program or extension installed in order to view the manual.

Mission Manual:

Selecting this entry will open the active Mission Manual, so the Music Mission manual in this case.

Download Debug Report:

Select to download and save the Anubis Debug Report. This report should be sent to the Merging team when required, for debugging purpose and the investigation of encountered problems.

Bus Routing Matrix (remote)

The web us routing is based on the same principals as the TFT Debug Routing but differs on its UI by showing a matrix view.

A matrix view will be open upon selection and provide the user with a easy Mono or Stereo Matrix Patch. Simply select the Mixer Bus (top row) and select the joining point of the Outputs Modules, to open the patch dialog.

Remote Web Access Bus Routing Matrix

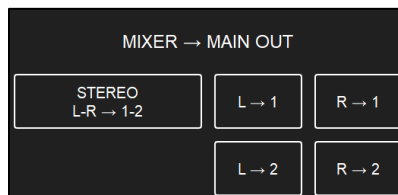
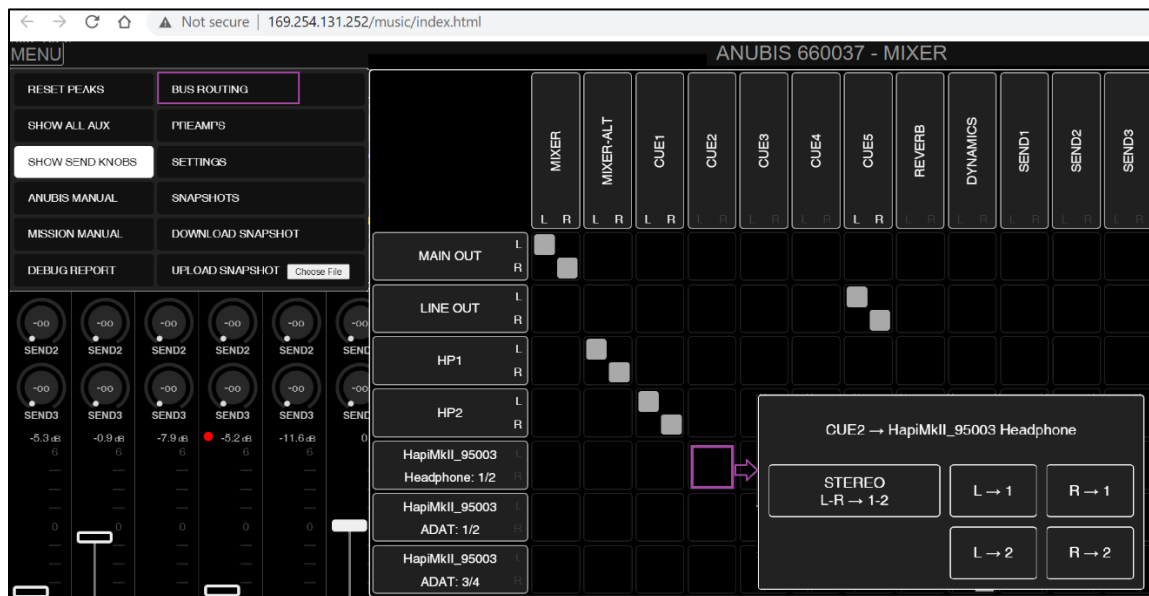

- Stereo L-R -> 1-2: Routes the Bus to the Stereo Channel Pair (1-2) of the Anubis
- L -> 1: Route the Bus to the Left channel to the Anubis (out 1)
- R -> 1: Route the Bus to the Right channel of the Anubis (out 1)
- L -> 2: Route the Bus to the Left channel to the Anubis (out 2)
- R -> 2: Route the Bus to the Right channel of the Anubis (out 2)

Note: selecting the L-1 and L-2 will select one or the other, for such patching simple select Stereo

Music Mission Remote control

Remote control all the elements of the Music Mission from your browser (Chrome recommended)

In the example below Merging+Reverb Effect is open, note that the Reverb also has an EQ available

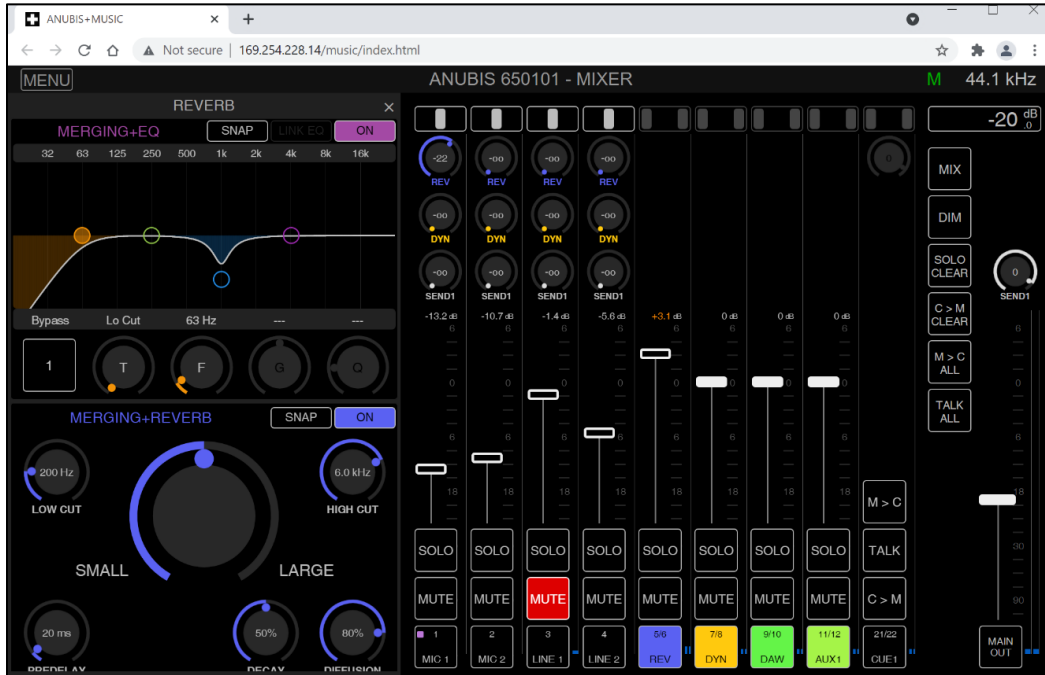

In the example below Merging+EQ and MERGING+Dynamics Effect are opened for remote control

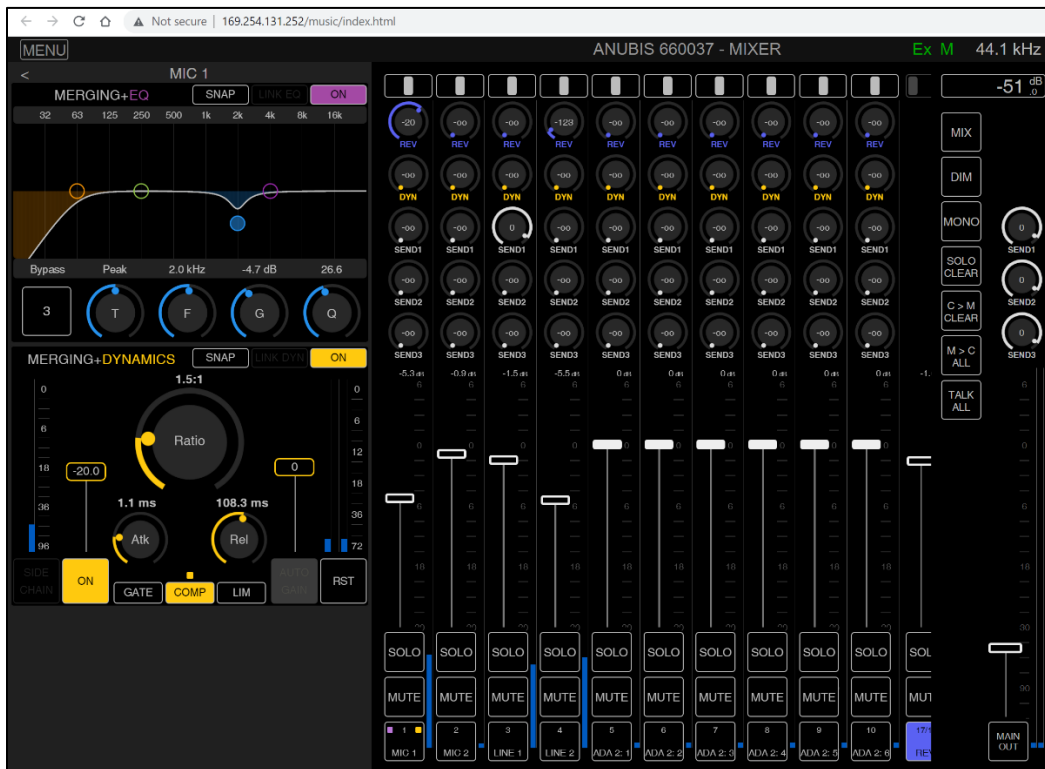

PreAmps Remote Control

Anubis Remote PreAmps page with Peered AD module channels from a Merging Hapi.

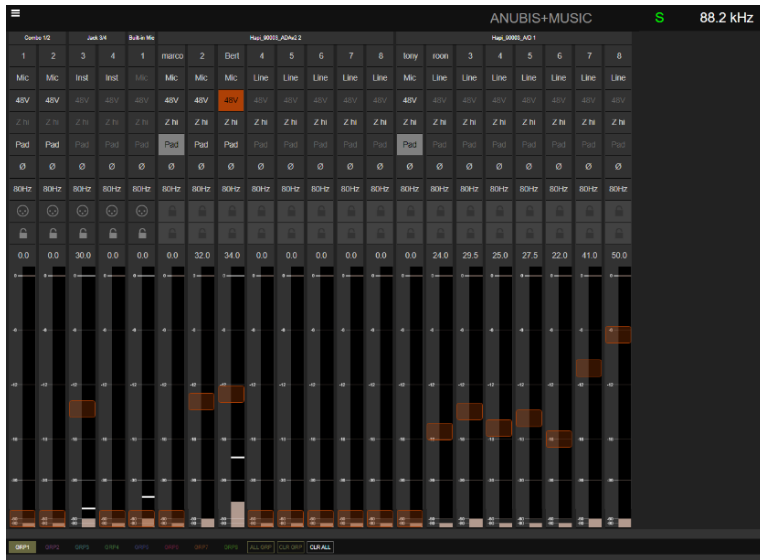

Full remote control of the Anubis PreAmps from your browser (Chrome recommended)

- Support for up to 8 groups



Select one of the group, and then select the inputs numbering/name section to add them to a group.

- Naming of channels.

Mouse+Click in the Channels numbering section in order to rename an input channel.

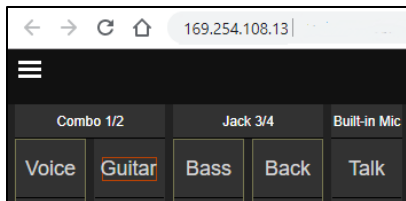

Note: Naming's are saved in Anubis presets

- VU meters

Input Gain level indication in dB

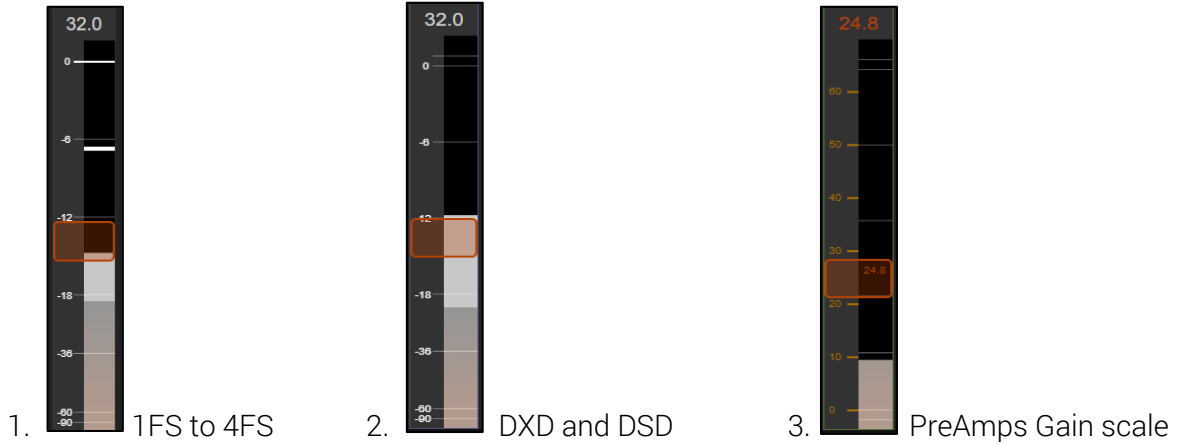

1. PreAmps Input Metering scale from 44.1kHz to 192kHz
2. PreAmps Input Metering scale changes when in DXD and DSD mode, in order to represent the headroom offered by DSD, as 0 dBFS = +6dB SA-CD
3. When changing the gain the Metering scale will change to represent the gain scale level in dB. This scale is only visible while the gain is being adjusted.
Range: 0dB to +66dB

- Peak reset



Click on the peak hold in order to reset a peak.

- Reset Faders unity.

Reset all the faders (gain) by double clicking on the fader itself.

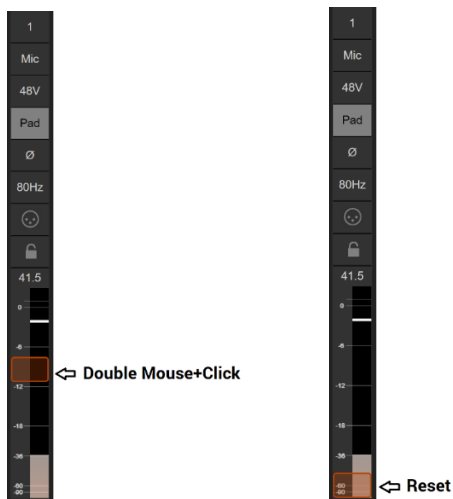

Remote Settings

The Web Access now provides remote control of the Anubis main Settings.

Note: Not all of the Mission settings are available in remote control.

Select Show Settings from the menu option in order to open the Settings remote layout.

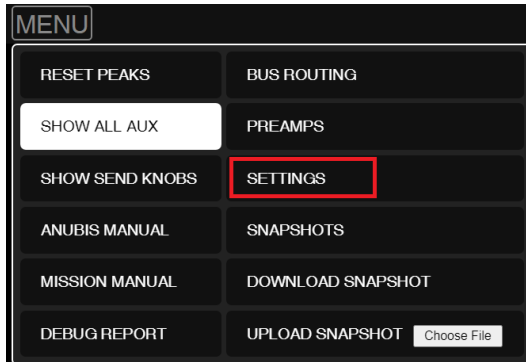

Click on the setting entry line or + if you want to open a specific setting.

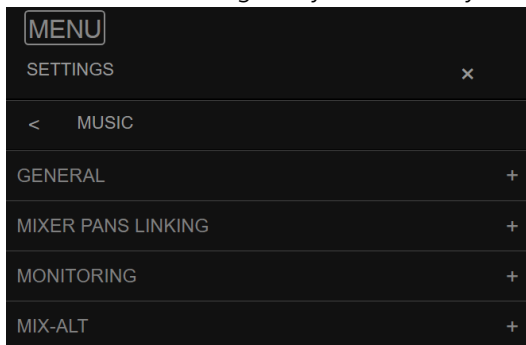

GENERAL SETTINGS

MENU

SETTINGS x

< GENERAL

SAMPLE RATE

Sampling Rate 96.0 kHz

Auto

A/D Mode in DXD/DSD DXD

FRAME MODE

Latency AES67 (48)

CLOCK

PTP Master

NETWORK

Interface 1

Type Auto

Address 169.254.131.252

Netmask 255.255.0.0

Gateway 0.0.0.0

Apply & Reboot

DATE & TIME

Current Host Date & Time 4/21/2021, 5:09:21 PM

Apply Date & Time to device

MUSIC SETTINGS

MENU

SETTINGS x

< MUSIC

GENERAL

Expert Mode

MIXER PANS LINKING

CUE 1

CUE 2

CUE 3

CUE 4

CUE 5

REVERB

DYNAMICS

MONITORING

REF Level (dB) -20

DIM Level (dB) -20

SOLO Exclusive

MIX-ALT

MIX-ALT Mode MIX-ALT

MIX-ALT Crossfeed (%) 0

A/B or SUB Trim (dB) 0

INFORMATION

MENU

SETTINGS x

< INFORMATION

VERSION

Firmware Version 1.2.1b47321

Serial Number A660037

Boards Run Main:2 Front:5 UI:5

STATUS

Temperature 43°C

Cores 23% 0%

Memory 49%

DEVICE

Name Anubis_660037

Type Premium

Note: All changed settings parameters will be reflected on the Anubis itself.

Snapshots:

18 snapshots are available within the Anubis Music Mission, you can remotely save or recall those.

1 record guit	N/A	N/A
2 record guitars Kemper	N/A	N/A
3 Vocals recording	N/A	N/A
4 BASS recording	N/A	N/A
N/A	N/A	N/A
6 MIXING 1	N/A	18 MY DEFAULT

192.168.1.120:8092 says

NAME

OK Cancel

NAME

COMMENT

COLOR

STORE UPDATE INFO DELETE

Recall a Snapshot will recall the entire Anubis configuration.

Download Snapshots:

Select to download and save an Anubis Snapshot to an external drive. The users will need to browse and select the folder in which they would like to save their Anubis preset .mumi file.

Note: Monitor Mission presets file extensions are .momi while Music Mission Snapshots are .mumi

Tablets Remote Access - Using the Anubis IP Address

Connect your Anubis to your network while making sure that it has a direct connection to a Wi-Fi Access Point.

Find the Anubis IP address under Settings > General into the Network IP address entry

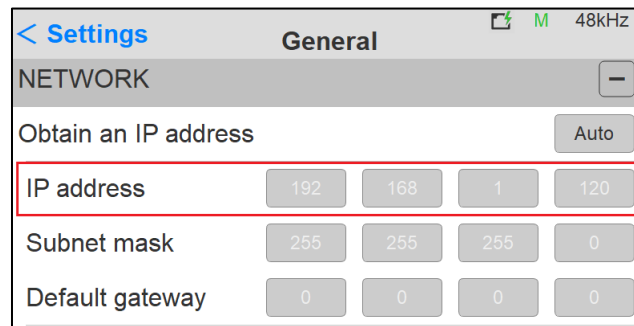

Type your Anubis IP address in the web browser and press enter to open the Remote Web User Interface



This method works with Chrome, Firefox, Opera and Safari, but does not work with Microsoft Edge.

Note: Merging certifies and recommends the use of Google Chrome.

TROUBLESHOOTING

In progress.

PROBLEM	POSSIBLE CAUSE	SOLUTION
Anubis		

FOR MORE **INFORMATION**

MERGING+ANUBIS WEBSITE

<https://www.merging.com/anubis>

MUSIC+MISSION FAQ

<https://confluence.merging.com/pages/viewpage.action?pageId=86212659>

MERGING+ANUBIS Knowledge Database, FAQs and Tutorials

<https://confluence.merging.com/display/public/doc/MERGING+ANUBIS>

MERGING+ANUBIS Downloads

<https://www.merging.com/anubis/download>

MERGING+ANUBIS USE CASES

<https://confluence.merging.com/pages/viewpage.action?pageId=60031175>

MERGING SUPPORT

support@merging.com

MERGING YouTube CHANNEL

https://www.youtube.com/channel/UCR5g_dlb9dYnXTrVDWMshgw